



**A-1 VERITAS**  
Surgident Co



# DENTAL

INSTRUMENTS CATELOGE



## Profile

Welcome to **A-1 VERITAS Surgident Co**, - top certified manufacturer and exporter of surgical and dental instruments by ISO 13485 and CE, from Pakistan around the world since 2007. A-1 VERITAS has been manufacturing and exporting Surgical and dental instruments, life saving instruments for cater to the needs of valuable customers more effectively and efficiently with Products international quality and standards of competitive prices. The quality management system has been properly implemented and is successfully working at all production stages. We carry out all the necessary tests, inspections and process control activities to ensure that there is no problem with the instruments performance.

Today, our company with continuous growing rate of turnover is one of the fastest growing groups in the country. Our company is fostering that position through expansions of our core businesses and introduction of advanced technology-based products.

Since its foundation, A-1 VERITAS has achieved the reputation for producing reliable and best Quality surgical instruments for domestic and export market. We are biggest supplier of military hospitals in domestic market. The reason behind the company's successful reputation and reliable products is its stringent quality control procedure, economical prices and prompt delivery. Today it has grown into one of the most dynamically versatile manufacturer of surgical and dental instruments.

At A-1 VERITAS, we strive for the highest level of expertise in knowledge of our products and for a solid understanding of every customer's business. Our goal is to develop an ongoing relationship with each of our customers that is built on Trust, best quality and consistency. We look to provide service that exceeds not only our customer's expectations, but industry standards as well.

**A-1 VERITAS Surgident co.**

<b>41   Extracting Forceps</b>	<b>01 - 22</b>
<b>42   Root Elevators</b>	<b>23 - 37</b>
<b>43   Diagnostic, Probes, Scalers, Filling &amp; Laboratory Instruments</b>	<b>38 - 85</b>
<b>44   Maxillofacial Surgery Instruments</b>	<b>86 - 103</b>
<b>45   Orthodontic Instruments &amp; Pliers</b>	<b>104 - 115</b>
<b>46   Dental Implant Instruments</b>	<b>116 - 156</b>
<b>47   Impression tray &amp; Hollowwares</b>	<b>157 - 159</b>

**EXTRACTING FORCEPS**

The diagram illustrates the application of four types of extracting forceps to various teeth in the upper and lower dental arches. The teeth are numbered according to FDI notation, and the forceps types are indicated by colored dots and boxes.

**Upper Arch (Maxilla):**

- English Pattern (Blue dots):** 1, 107, 10, 17, 10, 67, 88, 89, 94, 18, 28.
- English Pattern, Anatomic Handle (Yellow dots):** 29, 30, 108, 113, 1, 29, 30, 113, 7, 18, 44N, 51, 52, 53, 65, 89, 92, 94, 95, 96, 11, 21, 22, 23, 24, 25, 26, 27, 28.
- American Pattern (Green dots):** 10, 18, 19, 67, 88, 90, 95.
- Deep Grip Forceps (Red dots):** 37, 138, 37, 136, 138, 163, 37, 138, 39, 157, 128, 159, 39, 157, 158, 39, 157, 158.

**Lower Arch (Mandible):**

- English Pattern (Blue dots):** 33, 74, 75A.
- English Pattern, Anatomic Handle (Purple dots):** 22, 23, 24, 73, 79, 48, 47, 46, 45, 44, 43, 42, 41, 31, 32, 33, 34, 35, 36, 37, 38, 16, 22, 73, 79, 86, 89, 13, 75, 13, 74, 75A.
- American Pattern (Green dots):** 123, 143, 123, 162.
- Deep Grip Forceps (Red dots):** 160, 161, 123, 143, 160, 161.

**Forceps Types:**

- English Pattern:** Standard straight forceps with a simple beak.
- English Pattern, Anatomic Handle:** Similar to the English Pattern but with a curved, ergonomic handle.
- American Pattern:** Features a long, curved beak and a textured grip on the handle.
- Deep Grip Forceps:** Similar to the American Pattern but with a textured grip on the handle and yellow-colored accents.

- Щипцы экстракционные (английская форма)
- Daviers (Forme Anglaise)
- Zahnzangen (Englische Form)
- Щипці екстракційні (англійська форма)
- Forceps de Extracción (Forme Inglesa)
- استخراج الملقط (نمط اللغة الإنجليزية)



**41.8101.01**  
Fig. 1  
Upper Centrals  
and Canines



**41.8102.02**  
Fig. 2  
Upper Laterals  
and Canines



**41.8103.04**  
Fig. 4  
Lower Incisors  
and Canines



**41.8104.07**  
Fig. 7  
Upper Premolars



**41.8105.08**  
Fig. 8  
Lower Premolars



**41.8106.13**  
Fig. 13  
Lower Premolars



**41.8107.17**  
Fig. 17  
Upper Molars,  
Right



**41.8108.18**  
Fig. 18  
Upper Molars,  
Left



**41.8109.21**  
Fig. 21  
Lower Molar



**41.8110.22**  
Fig. 22  
Lower Molar

- Щипцы экстракционные (английская форма)
- Daviers (Forme Anglaise)
- Zahnzangen (Englische Form)
- Щипці екстракційні (англійська форма)
- Forceps de Extracción (Forme Inglesa)
- استخراج الملقط (تمط اللغة الإنجليزية)



41.8111.18  
# 18A  
upper molars



41.8112.19  
# 19  
upper third molars



41.8113.20  
# 20  
lower third molar



41.8114.24  
# 24  
lower molar, right



41.8115.29  
# 29  
upper roots



41.8116.30  
# 30  
Upper Roots



41.8117.33  
# 33  
lower roots



41.8118.33  
# 33A  
Lower Roots



41.8119.33  
# 33M  
Lower roots  
with long beak



41.8120.46  
# 46L



41.8121.51  
# 51  
Upper Roots



41.8122.51  
# 51A  
Upper Roots

- Щипцы экстракционные (английская форма)
- Daviers (Forme Anglaise)
- Zahnzangen (Englische Form)
- Щипці екстракційні (англійська форма)
- Forceps de Extracción (Forme Inglesa)
- استخراج الملقط (نمط اللغة الإنجليزية)



**WISDOM EXTRACTING FORCEPS**



**41.8123.22**  
Routurier  
(# 22 1/2 L)  
lower molars and  
wisdoms, left

**41.8124.22**  
Routurier  
(# 22 1/2 R)  
lower molars and  
wisdoms, right



**41.8125.33**  
Routurier  
(# 33 1/2 L)  
lower molar and  
wisdom roots, left

**41.8126.33**  
Routurier  
(# 33 1/2 R)  
lower molar and  
wisdom roots, right

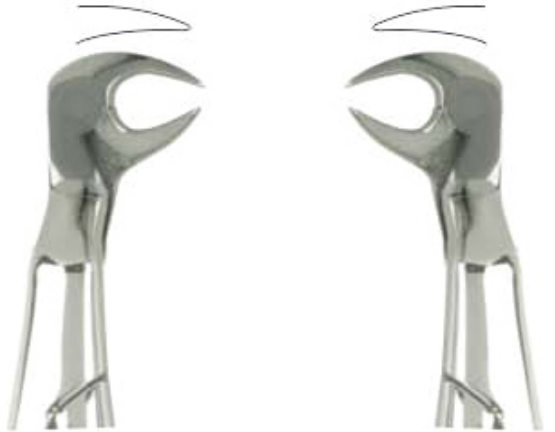

**41.8127.18**  
Fig. 186L  
lower molars

**41.8128.18**  
Fig. 186R  
lower molars



**41.8129.51**  
# 51AL



**41.8130.67**  
# 67  
Upper Third Molars



**41.8131.67**  
# 67A  
Upper Third Molars



**41.8132.79**  
# 79  
Lower Third Molars

- Щипцы экстракционные (английская форма)
- Daviers (Forme Anglaise)
- Zahnzangen (Englische Form)

- Щипці екстракційні (англійська форма)
- Forceps de Extracción (Forme Inglesa)
- استخراج المنقط (نمط النغمة الإنجليزية)



41.8133.73  
# 73  
Lower Molars

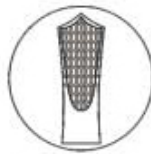

41.8134.73  
# 73 A  
lower molars



41.8135.73  
# 73 S



41.8136.74  
# 74  
Lower Roots



41.8137.74  
# 74N  
Lower Roots



41.8138.75  
# 75  
Lower Premolars



41.8139.86  
# 86A  
Lower Molars



41.8140.86  
# 86B  
lower molars



41.8141.86  
# 86C  
lower molars



41.8142.87  
# 87  
Lower Molars



41.8143.89  
# 89  
Upper Molars,  
Right



41.8144.90  
# 90  
Upper Molars,  
Left



- Щипцы экстракционные (английская форма)
- Daviers (Forme Anglaise)
- Zahnzangen (Englische Form)
- Щипці екстракційні (англійська форма)
- Forceps de Extracción (Forme Inglesa)
- استخراج الملقط (نمط اللغة الإنجليزية)

A-TRAUMATIC EXTRACTION  
Improved tapered beaks for complete root contact. Cross serrations.  
Deep Gripe Extracting Forceps



- No Fracture
- No Tissue Damage
- Extraction With Easy



Thin Tip

**41.8145.34**  
# 34

Upper incisors and  
premolars  
deep-gripping



Wide Tip

**41.8146.34**  
# 34A

Upper centrals / canines  
deep-gripping



Thin Tip

**41.8147.35**  
Fig. 35

upper premolars  
deep-gripping



Wide Tip

**41.8148.35**  
# 35A

Upper incisors and  
premolars  
deep-gripping



Thin Tip

**41.8149.36**  
# 36

Lower premolars  
deep-gripping



Wide Tip

**41.8150.36**  
# 36A

Lower premolars  
deep-gripping



**41.8151.33**  
# 336

lower premolars  
deep-gripping



**41.8152.07**  
F-7C

lower molar



**41.8153.09**  
# 9

Apex Forceps Lower Universal  
Deep Root Pick



**41.8154.79**  
# 79N

Lower third molars  
deep-gripping



**41.8155.79**  
# 79

Lower Third Molars

- Щипцы экстракционные (английская форма)
- Daviers (Forme Anglaise)
- Zahnzangen (Englische Form)
- Щипці екстракційні (англійська форма)
- Forceps de Extracció (Forme Inglesa)
- استخراج الملقط (تمط اللغة الإنجليزية)

## DEEP GRIP FORCEPS



41.8156.14  
# 146

Apex Forceps Lower Root  
Deep Root Pick



41.8157.15  
# 153

Apex Forceps Upper Root  
Deep Root Pick



41.8158.14  
# 149

Apex Forceps Upper Root  
Deep Root Pick



41.8159.44  
Fig. 44



41.8160.44  
Fig. 44Z



41.8161.45  
Fig. 45Z



41.8162.46  
# 46XL  
Apex Forceps Lower Root  
Deep Root Pick



41.8163.67  
# 67  
Upper Third Molars



41.8164.67  
# 67A  
Upper Third Molars



41.8165.67  
# 67N  
Lower third molars  
deep-gripping



41.8166.33  
# 331  
upper roots  
deep-gripping



**41.8167.01**  
Fig. 1  
upper  
laterals  
and canines



**41.8167.10** Set of 10 Pieces  
Fig. 1  
Fig. 7  
Fig. 13  
Fig. 17  
Fig. 18  
Fig. 22  
Fig. 51A  
Fig. 67  
Fig. 74N  
Fig. 79

- Щипцы экстракционные (английская форма)
- Daviers (Forme Anglaise)
- Zahnzangen (Englische Form)
- Щипці екстракційні (англійська форма)
- Forceps de Extracción (Forme Inglesa)
- استخراج الملقط (نمط اللغة الإنجليزية)

**41.8167.07**  
Fig. 7  
upper  
premolars



**41.8167.13**  
Fig. 13  
lower  
premolars



**41.8167.17**  
Fig. 17  
upper  
molars,  
right



**41.8167.18**  
Fig. 18  
upper  
molars  
left



**41.8167.22**  
Fig. 22  
lower  
roots



**41.8167.51**  
Fig. 51A  
upper roots



**41.8167.67**  
Fig. 67  
upper third  
molars



**41.8167.74**  
Fig. 74N  
lower  
molar



**41.8167.79**  
Fig. 79  
lower third  
molars



- Щипцы экстракционные
- Daviers
- Zahnzangen
- Щипці екстракційні
- Forceps de Extracción
- استخراج الملقط

Pediatric Tooth Extracting Forceps Set



**41.8168.51**  
English Pattern Klein #51S  
Pedodontic Upper root



**41.8171.13**  
English Pattern Klein #137  
Pedodontic, Upper Incisors Spring handle



**41.8172.05**  
English Pattern Klein #5  
Pedodontic Lower Incisors.



**41.8169.13**  
English Pattern Klein #139  
Pedodontic Upper Premolars

Baby Tooth Extraction Forceps



**41.8168.17**  
Fig. # 01 to 07  
Set of 7 Pieces



**41.8173.07**  
English Pattern Klein #7  
Pedodontic Lower Roots,



**41.8170.03**  
English Pattern Klein #3  
Pedodontic Upper Molars Universal

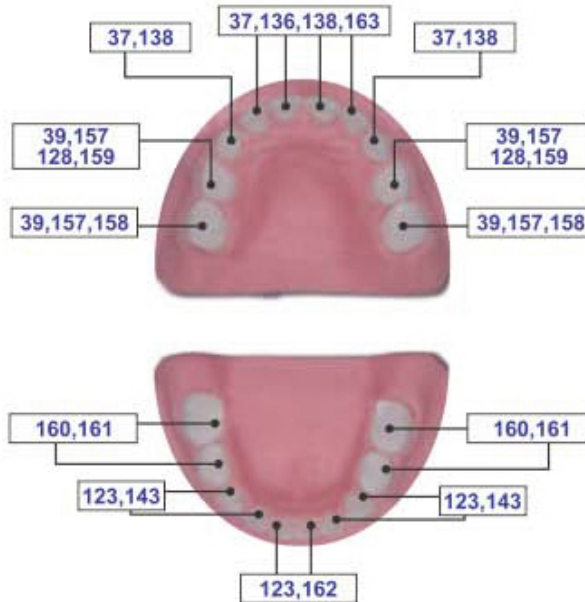

**41.8174.06**  
English Pattern Klein #6  
Pedodontic Lower Molars, Spring Handle

- Щипцы экстракционные (американская форма)
- Daviers - forme américaine
- Fórceps de extracción - forma americana
- Щипці екстракційні (американська форма)
- Pinzere per estrazione - forma americana
- استخراج الملقط (النمط الأمريكي)



**41.8175.01**  
# 1STD  
Winter  
upper centrals and canines



**41.8176.01**  
Fig. 1  
upper incisors  
and roots



**41.8177.15**  
Cryer  
Fig. 150

- Щипцы экстракционные (американская форма)
- Daviers - forme américaine
- Fórceps de extracción - forma americana
- Щипці екстракційні (американська форма)
- Pinzoper per estrazione - forma americana
- استخراج المنقط (النمط الأمريكي)



**41.8178.15**  
Fig. 150A  
Cryer

upper incisors, premolars, roots



**41.8179.62**  
Fig. 62  
incisors, premolars,  
deciduous teeth



**41.8180.10**  
# 10S  
upper roots



**41.8181.17**  
# 17  
lower molars



**41.8182.18**  
Harris  
Fig. 18R



**41.8183.18**  
Harris  
Fig. 18L



- Щипцы экстракционные (американская форма)
- Daviers - forme americane
- Fórceps de extracción - forma americana
- Щипці екстракційні (американська форма)
- Pinzere per estrazione - forma americana
- استخراج الملقط (النمط الأمريكي)



**41.8184.21**  
Fig. 210  
upper third molars



**41.8185.53**  
Fig. 53R  
upper molars, right



**41.8186.53**  
Fig. 53L  
upper molars, left



**41.8187.88**  
NEVIUS  
Fig. 88R



- Щипцы экстракционные (американская форма)
- Daviers - forme américaine
- Fórceps de extracción - forma americana
- Щипці екстракційні (американська форма)
- Pinzere per estrazione - forma americana
- استخراج الملقط (النمط الأمريكي)



**41.8188.24**  
Fig. 24  
upper molars



**41.8189.21**  
# 210S  
upper third molars



**41.8190.21**  
# 210H  
upper third molars



**41.8191.28**  
# 286  
Upper Roots,  
Premolars, Incisors



**41.8192.99**  
# 99C  
Kells  
upper incisors,  
canines, premolars



**41.8193.22**  
# 222  
lower third molars



**41.8194.28**  
# 286  
Lower Molar



- Щипцы экстракционные (американская форма)
- Daviers - forme américaine
- Fórceps de extracción - forma americana
- Щипці екстракційні (американська форма)
- Pinzoper per estrazione - forma americana
- استخراج الملقط (النمط الأمريكي)



**41.8195.88**  
Nevius  
Fig. 88L  
upper molars, left



**41.8196.65**  
Fig. 65  
upper incisors  
and roots



**41.8197.32**  
Parmly Fig. 32A  
upper premolars  
and roots



**41.8198.32**  
Parmly Fig. 32  
upper premolars  
and molars



- Щипцы экстракционные (американская форма)
- Daviers - forme américaine
- Fórceps de extracción - forma americana
- Щипці екстракційні (американська форма)
- Pinzere per estrazione - forma americana
- استخراج المنطق (النمط الأمريكي)

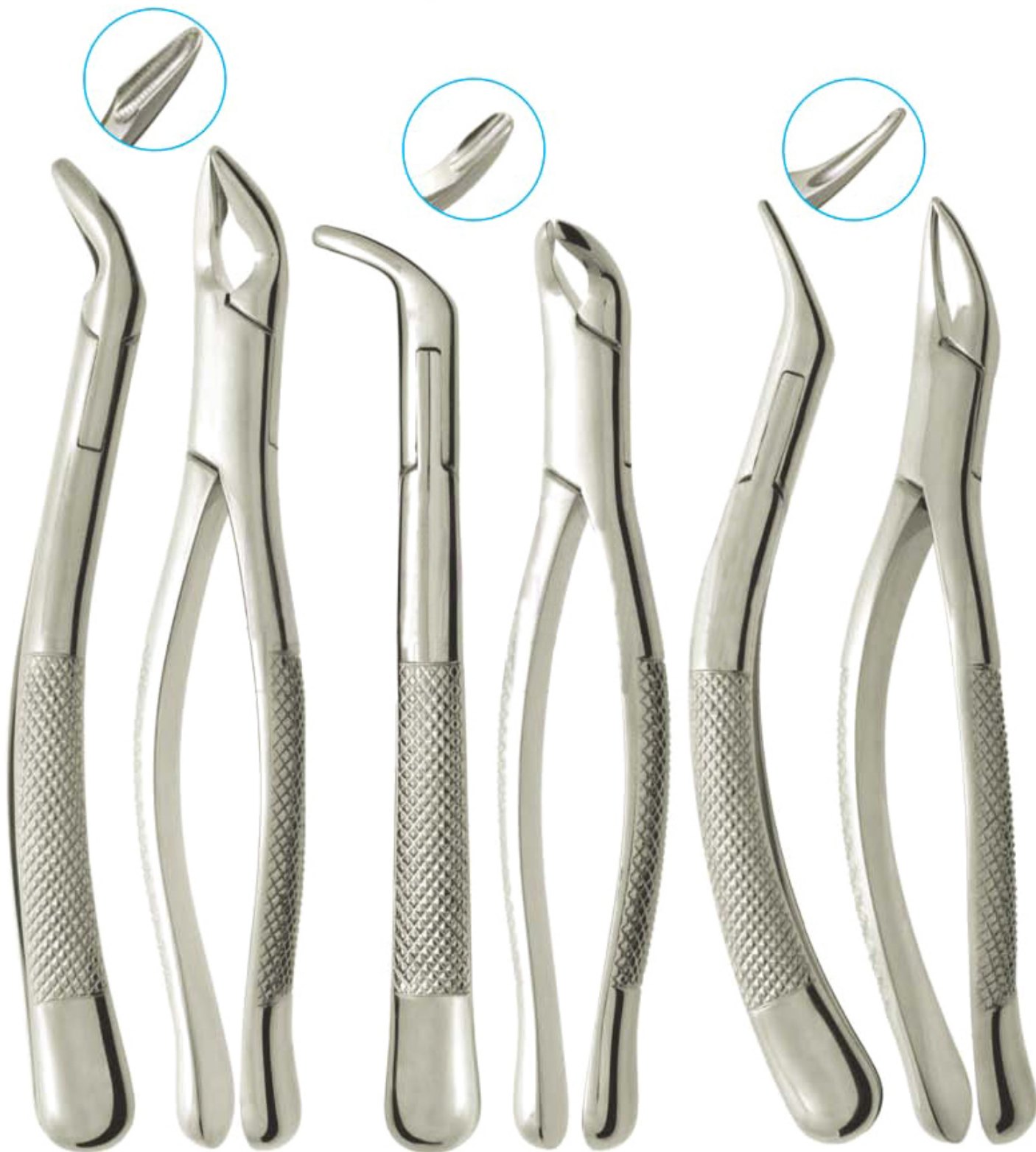

41.8199.01  
COHEN  
universal

41.8200.20  
Fig. 203  
lower incisors  
and roots

41.8201.69  
Tomes Fig. 69  
upper and lower  
roots



- Щипцы экстракционные (американская форма)
- Daviers - forme américaine
- Fórceps de extracción - forma americana
- Щипці екстракційні (американська форма)
- Pinzper per estrazione - forma americana
- استخراج المفلط (النمط الأمريكي)



**41.8202.23**  
Fig. 23  
lower molars



**41.8203.16**  
Fig. 16  
lower molars



**41.8204.05**  
Physic Fig. 5  
lower third molars



**41.8205.15**  
Harris Fig. 15  
lower molars



**41.8206.10**  
Fig. 103

- Щипцы экстракционные (американская форма)
- Daviers - forme américaine
- Fórceps de extracción - forma americana
- Щипці екстракційні (американська форма)
- Pinzoper per estrazione - forma americana
- مستخرج الملغظ (النمط الأمريكي)

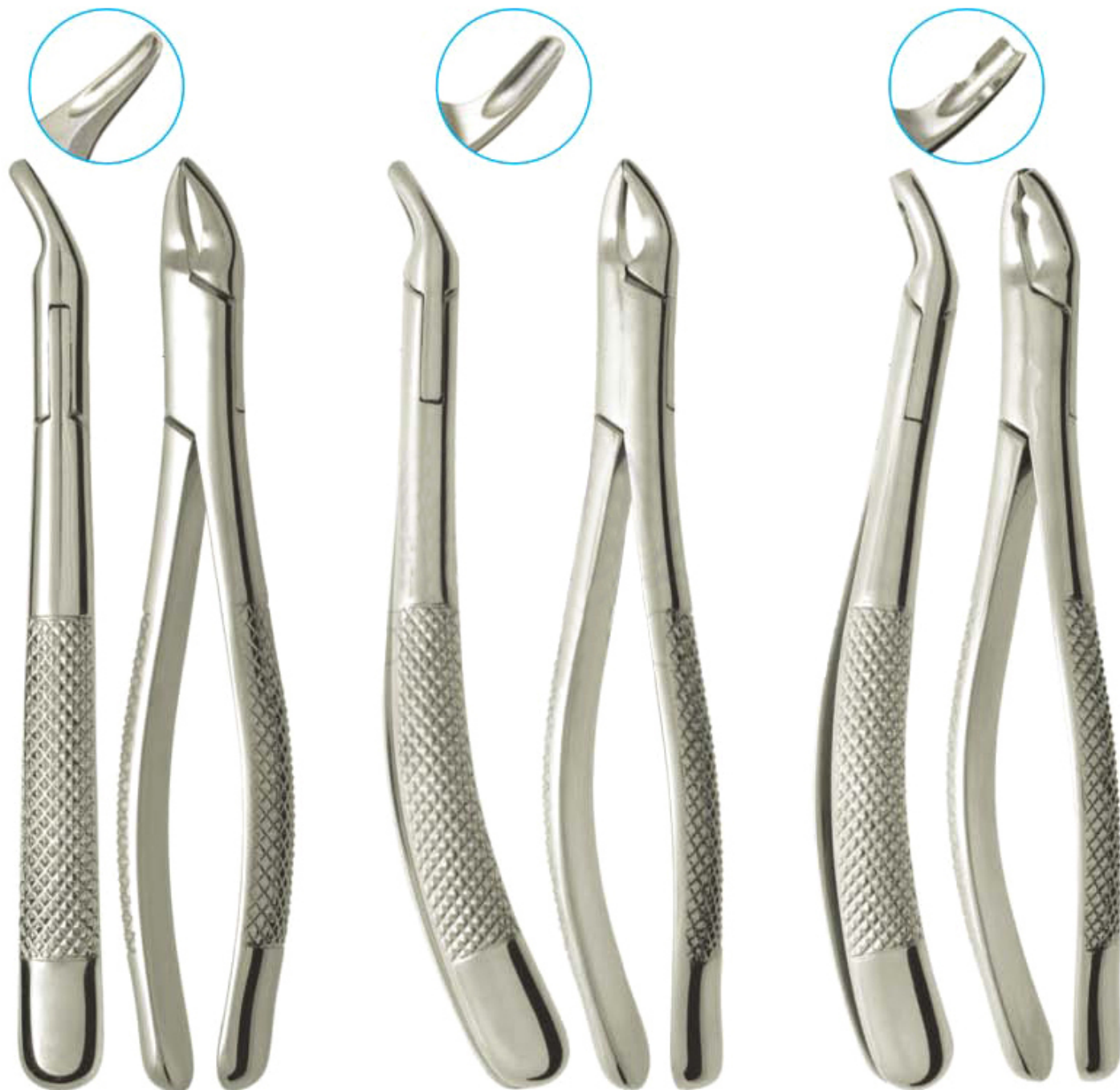

41.8207.10  
Hull  
Fig. 101  
Deciduous teeth

41.8208.15  
Cryer  
Fig. 150S  
upper teeth,  
for children

41.8209.15  
Fig. 150 AS

- Щипцы экстракционные (американская форма)
- Daviers - forme américaine
- Fôrceps de extracción - forma americana
- Щипці екстракційні (американська форма)
- Pinzeta per estrazione - forma americana
- استخراج الملقط (النمط الأمريكي)



**41.8210.15**  
Cryer  
Fig. 151  
lower teeth,  
for children

**41.8211.15**  
Fig. 151 S  
lower incisors,  
premolars, roots

**41.8212.15**  
Fig. 151 AS

- Щипцы экстракционные (американская форма)
- Daviers - forme américaine
- Fórceps de extracción - forma americana
- Щипці екстракційні (американська форма)
- Pinzere per estrazione - forma americana
- استخراج الملقط (النمط الأمريكي)



41.8213.16  
# 16S  
lower molars for children



41.8214.17  
# 17S  
lower molars



41.8215.23  
# 23 S  
Lower molars

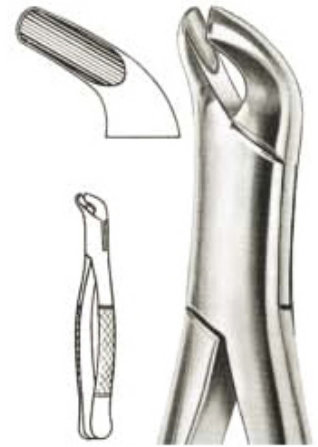

41.8216.27  
# 27  
lower molars



41.8217.18  
# 18LS  
upper molars left



41.8218.18  
# 18RS  
upper molars right



41.8219.85  
# 85 Tomas  
lower canines, premolars and molars



41.8220.85  
# 85A Tomas  
lower canines, premolars and molars



41.8221.69  
# 69S  
upper and lower roots



41.8222.99  
# 99A Kells  
upper incisors, canines, premolars



41.8223.21  
# 217  
lower molars

- Щипцы экстракционные (американская форма)
- Щипці екстракційні (американська форма)
- Daviers - forme américaine
- Pinzeper per estrazione - forma americana
- Férceps de extracción - forma americana
- استخراج الملقط (النمط الأمريكي)



**41.8224.10**  
#10 SK  
Upper Molars Sup



**41.8225.17**  
#17 SK Universal  
Lower Molars



**41.8226.23**  
#23 SK Universal  
Upper Molars



**41.8227.69**  
#69 SK Tomas  
upper and lower roots



**41.8228.99**  
#99 SK  
upper incisors,  
canines, premolars



**41.8229.15**  
#150 SK  
upper incisors,  
premolars, roots



**41.8230.15**  
#151 SK  
lower incisors,  
premolars, roots



**41.8231.22**  
#222 SK  
lower third molars

- Щипцы экстракционные (американская форма)
- Daviers - forme américaine
- Fórceps de extracción - forma americana
- Щипці екстракційні (американська форма)
- Pinzoper per estrazione - forma americana
- استخراج المنقط (النمط الأمريكي)



41.8232.01  
Fig. 1  
Upper Anterior

41.8233.23  
Lower Molar  
Fig. 23 Cow Horn



41.8234.74  
Fig. 74  
Lower Anterior



41.8235.88  
Fig. 88L  
Upper Molar Left



41.8236.88  
Fig. 88R  
Upper Molar Right



41.8237.74  
Fig. 74  
Lower Anterior



41.8238.10  
Fig. 106  
Lower Incisors



41.8239.17  
Fig. 174  
Extra Narrow  
Lower Anterior  
Apical Retention  
Forceps



41.8240.85  
Fig. 859  
Lower Molars  
Roots







- Шприцы стоматологические карпульные
  - Seringues à usage dentaire
  - Dentalspritzen
- Шприці стоматологічні карпульні
  - Jeringas dentales
  - المحاقن الأسنان



41.8241.18 1.8ML  
41.8241.22 2.2ML



41.8243.18 1.8ML  
41.8243.22 2.2ML



41.8244.18 1.8ML  
41.8244.22 2.2ML



41.8245.18 1.8ML  
41.8245.22 2.2ML



41.8246.18 1.8ML  
41.8246.22 2.2ML



41.8247.18 1.8ML  
41.8247.22 2.2ML



41.8242.18  
# 1001  
Intraligamental  
Anesthesia  
Syringe in  
Black Colour



41.8248.18 1.8ML  
41.8248.22 2.2ML  
Angled



41.8249.18 1.8ML  
Aluminium - Dark 1.8 ml



Type C  
41.8250.18 1.8ML  
41.8250.22 2.2ML



Type C  
41.8251.18 1.8ML  
41.8251.22 2.2ML



2-Ring  
41.8252.18 1.8ML 1.8ML  
41.8252.22 2.2ML 2.2ML



Aspirating Syringe  
41.8253.18 1.8ML  
41.8253.22 2.2ML



Cartridge Syringe  
41.8254.18 1.8ML  
41.8254.22 2.2ML



Cartridge Syringe  
41.8255.18 1.8ML  
41.8255.22 2.2ML



Cartridge Syringe  
41.8256.18 1.8ML  
41.8256.22 2.2ML

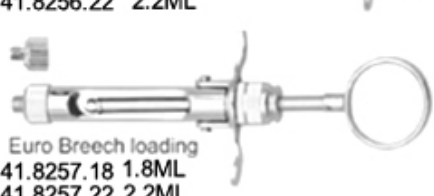

Euro Breech loading  
41.8257.18 1.8ML  
41.8257.22 2.2ML

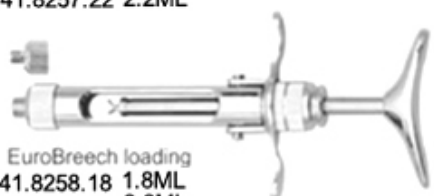

EuroBreech loading  
41.8258.18 1.8ML  
41.8258.22 2.2ML



Manual Aspirating Syringe  
41.8259.18 1.8ML  
41.8259.22 2.2ML



Quatro  
41.8260.18 1.8ML  
41.8260.22 2.2ML



Trio  
41.8261.18 1.8ML  
41.8261.22 2.2ML



Swedish Type  
41.8262.18 1.8ML  
41.8262.22 2.2ML



Ject Ultima  
41.8263.18 1.8ML  
41.8263.22 2.2ML  
Injects 0.05 ml with every click Supplied with angled and straight tubes



Ject angled  
41.8264.18 1.8ML  
41.8264.22 2.2ML



Ject Straight  
41.8265.18 1.8ML  
41.8265.22 2.2ML



Disc System  
41.8266.18 1.8ML  
41.8266.22 2.2ML



Disc System  
41.8267.18 1.8ML

- Костные кусачки
- Hohlmeißelzangen
- Pincès-gouges

- Кусачки для кісток
- Pinzas-gubias
- روجیورس العظام



41.8280.01  
Blumenthal  
15cm



41.8280.02  
Blumenthal  
15cm



41.8280.03  
Blumenthal  
15cm



41.8280.04  
Friedman  
14cm



41.8280.05  
Friedman  
14.5cm



41.8280.06  
Micro-Friedman  
14cm



41.8280.07  
Micro-Friedman  
15cm



41.8280.08  
Micro-Friedman  
16cm



41.8281.01  
Kleinert-Kutz  
18.5cm



41.8281.02  
Beyer  
18.5cm



41.8281.03  
Mead 1A  
18.5cm



41.8281.04  
Luer  
18.5cm

**ROOT ELEVATOR**

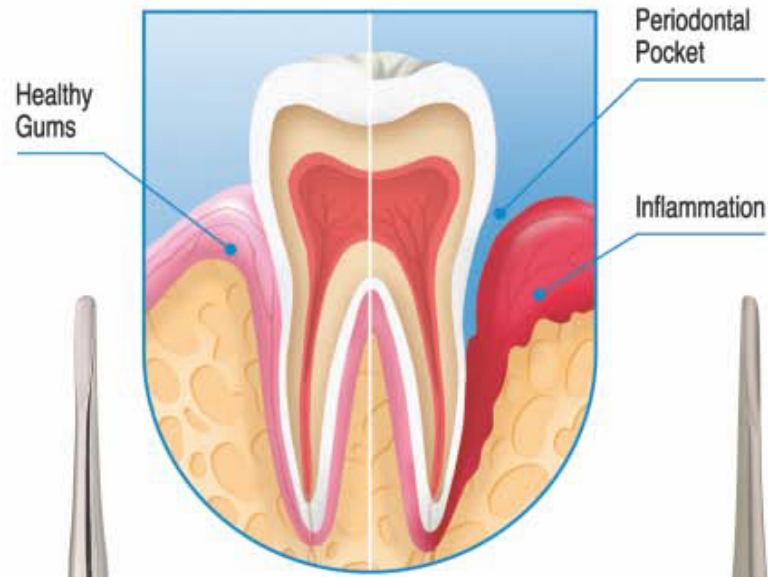

**HANDLES FOR ROOT ELEVATORS POINTS  
A, B, C, D**

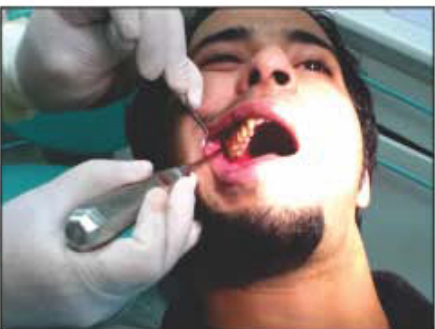
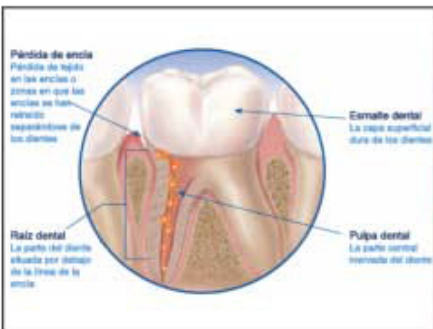

- Элеватор корневой экстракционный
- Elévateurs à racines
- Wurzelheber
- Слеватор корневий екстракційний
- Elevadores para raíces
- المصاعد الجذر

Apexo Root Elevators



Apexo

**42.8301.01**  
Apexo  
2.5x9mm  
Straight

**42.8301.02**  
Apexo  
2.7x9mm  
Straight

**42.8301.03**  
Apexo  
3.0x9mm  
Straight

**42.8301.04**  
Apexo  
2.5x9mm  
Curved

**42.8301.05**  
Apexo  
3.0x9mm  
Curved

**42.8301.06**  
Seldin  
3.0x14mm  
Straight

Luxator Root Elevators



Luxator

**42.8302.01**  
Luxator  
3mm  
straight

**42.8302.02**  
Luxator  
3mm  
curved

**42.8302.03**  
Luxator  
4mm  
straight

**42.8302.04**  
Luxator  
4mm  
curved

**42.8302.05**  
Luxator  
5mm  
straight

**42.8302.06**  
Luxator  
5mm  
curved

Bein Root Elevators



Bein

**42.8303.02**  
Bein 2mm

**42.8303.03**  
Bein 3mm

**42.8303.04**  
Bein 4mm

Seldin Root Elevators



Seldin

**42.8304.03**  
Flohr 1

**42.8304.04**  
Seldin 34S

**42.8304.05**  
Seldin 34

- Элеватор корневой экстракционный
- Élévateurs à racines
- Wurzelheber
- Єлеватор корневий екстракційний
- Elevadores para raices
- المصاعد الجذر

## Apexo Root Elevators



Apexo



42.8305.01  
Apexo  
2.5x9mm  
Straight



42.8305.02  
Apexo  
2.7x9mm  
Straight



42.8305.03  
Apexo  
3.0x9mm  
Straight



42.8305.04  
Apexo  
2.5x9mm  
Curved



42.8305.05  
Apexo  
3.0x9mm  
Curved



42.8305.06  
Seldin  
3.0x14mm  
Straight

## Luxator Root Elevators



Luxator



42.8306.01  
Luxator  
3mm  
straight



42.8306.02  
Luxator  
3mm  
curved



42.8306.03  
Luxator  
4mm  
straight



42.8306.04  
Luxator  
4mm  
curved



42.8306.05  
Luxator  
5mm  
straight



42.8306.06  
Luxator  
5mm  
curved

## Bein Root Elevators



Bein



42.8307.02  
Bein 2mm



42.8307.03  
Bein 3mm



42.8307.04  
Bein 4mm

## Seldin Root Elevators



Seldin



42.8308.03  
Flohr 1



42.8308.04  
Seldin 34S



42.8308.05  
Seldin 34

- Элеватор корневой экстракционный
- Elevateurs à racines
- Wurzelheber
- Элеватор корневий екстракційний
- Elevadores para raices
- المصاعد الجذر



**Apical Root Elevators**

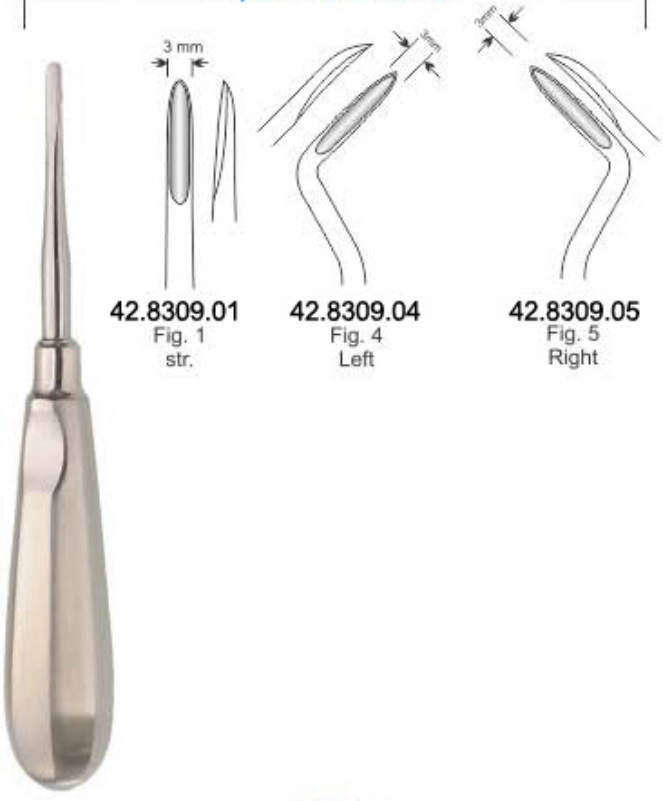

**Apical Root Elevators**

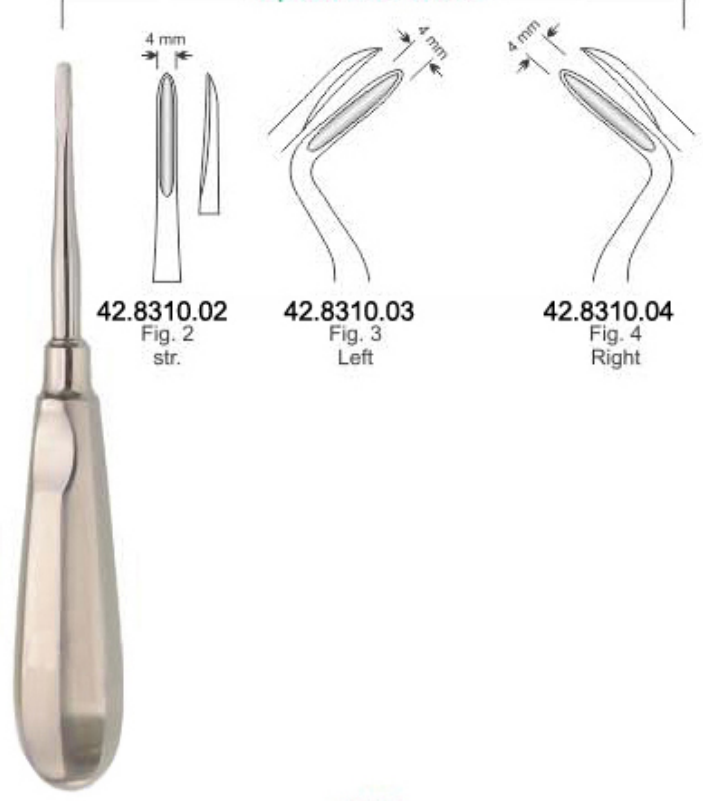

**Coupland Root Elevators**

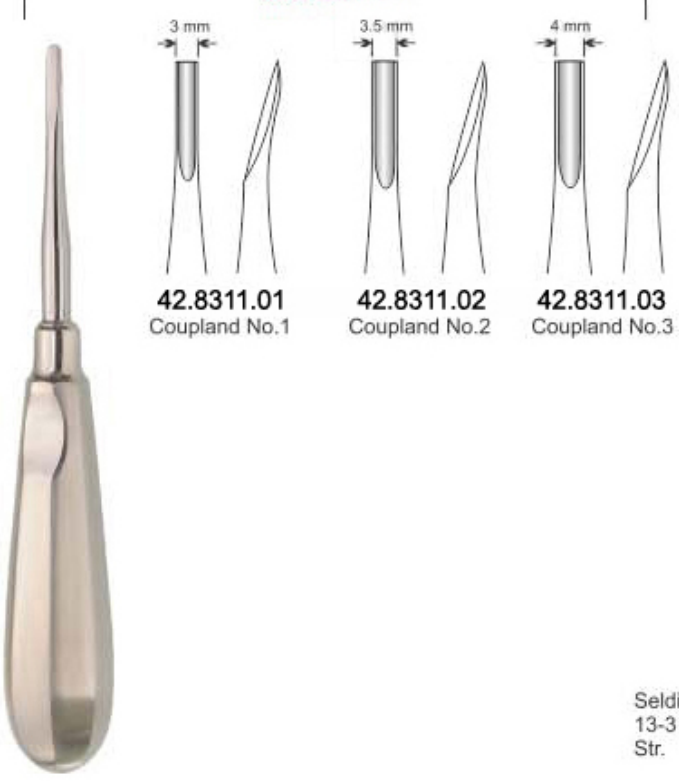

**Seldin Root Elevators**

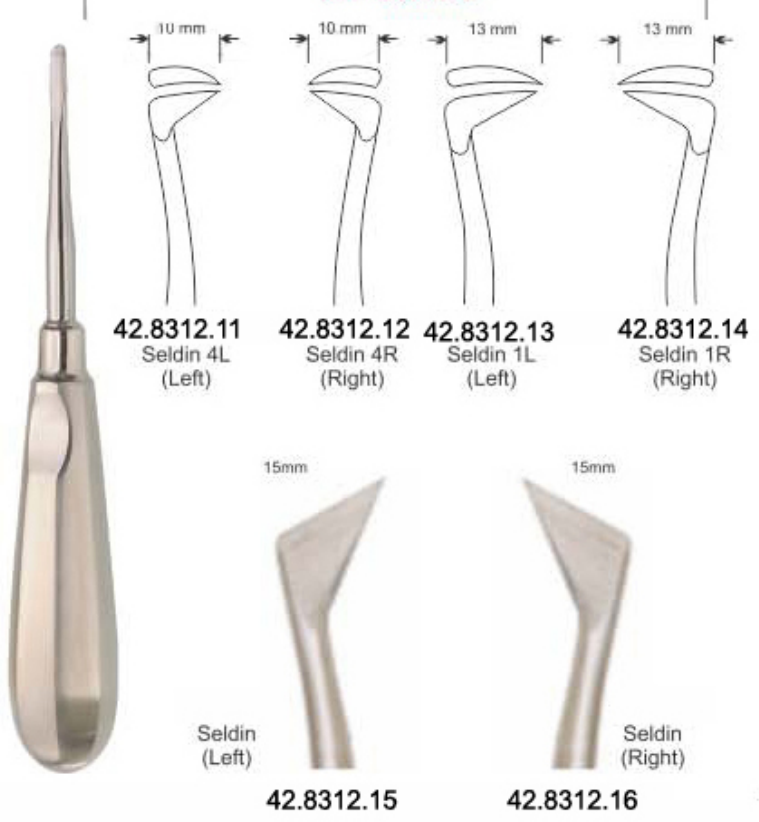

- Элеватор корневой экстракционный
- Elévateurs à racines
- Wurzelheber
- Слеватор корневий екстракційний
- Elevadores para raices
- المصاعد الجذر

**Apical Root Elevators**

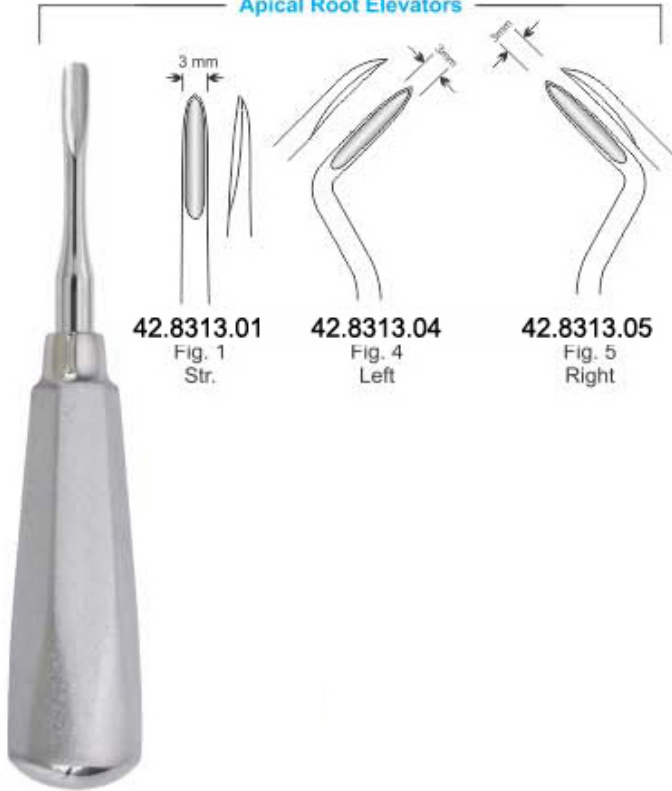

**Apical Root Elevators**



**Coupland Root Elevators**

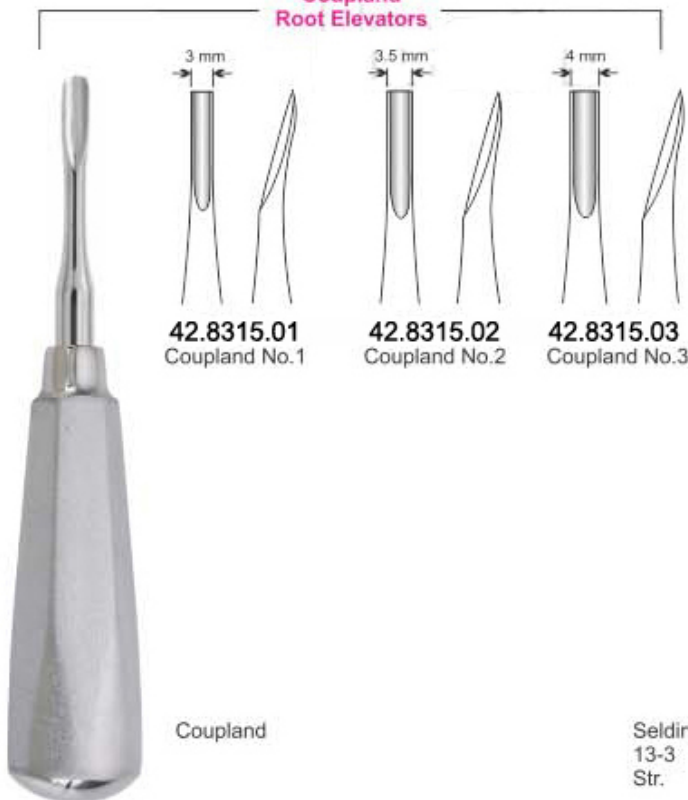

**Seldin Root Elevators**



- Элеватор корневой экстракционный
- Elévateurs à racines
- Wurzelheber
- Elevator corneviu extracționii
- Elevadores para raíces
- المصاعد الجذر



**Apical Root Elevators**

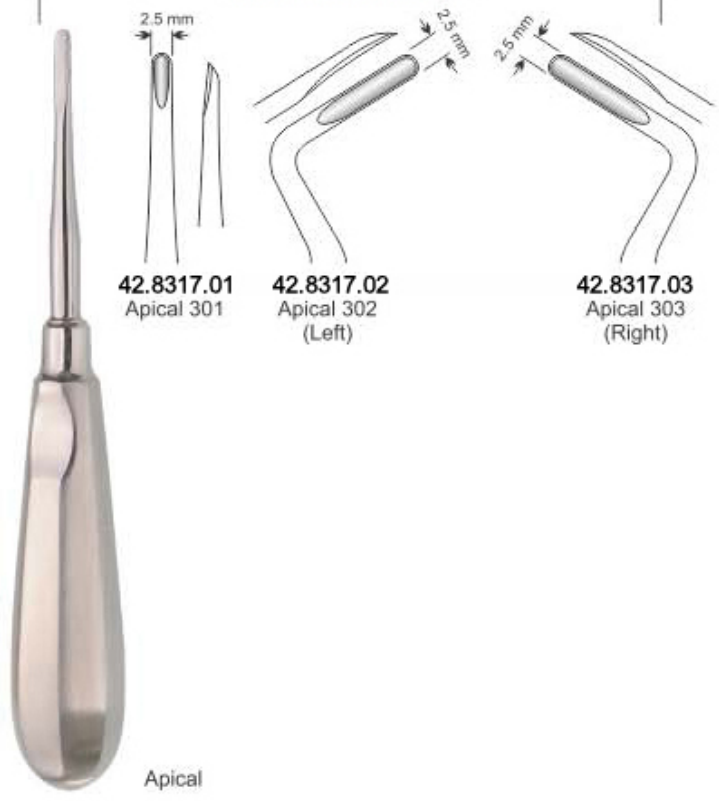

**Apical Root Elevators**

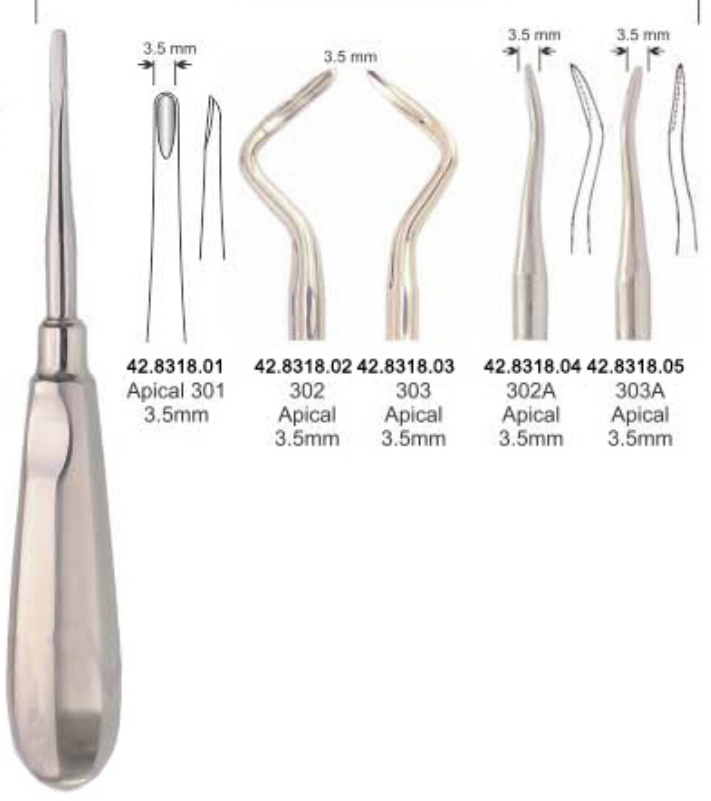

**Apical Root Elevators**



**Laxutor Root Elevators**





- Элеватор корневой экстракционный
- Elévateurs à racines
- Wurzelheber

- Єлеватор корневий екстракційний
- Elevadores para raíces
- المصاعد الجذر

## Lindo Levian Root Elevators

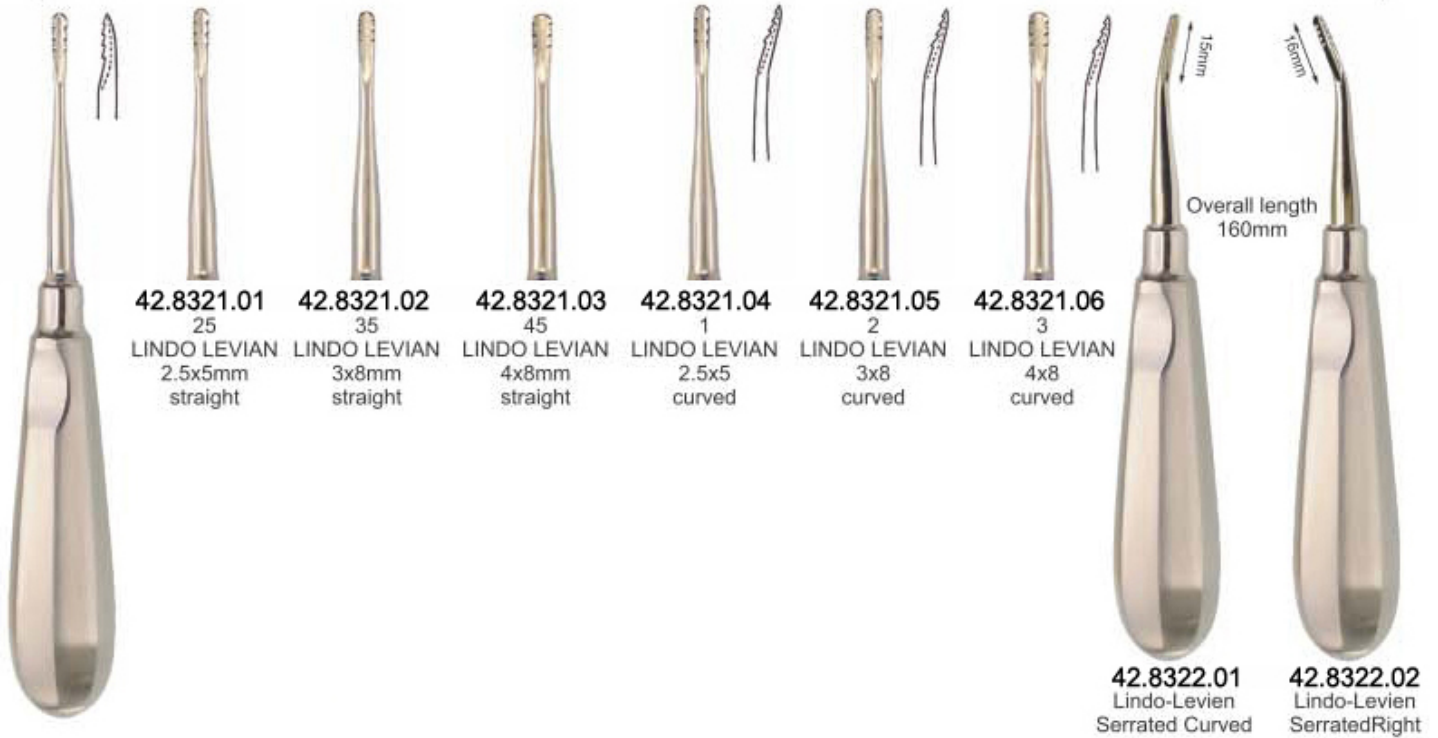

## Flohr Root Elevators



## Heidbrink Root Elevators

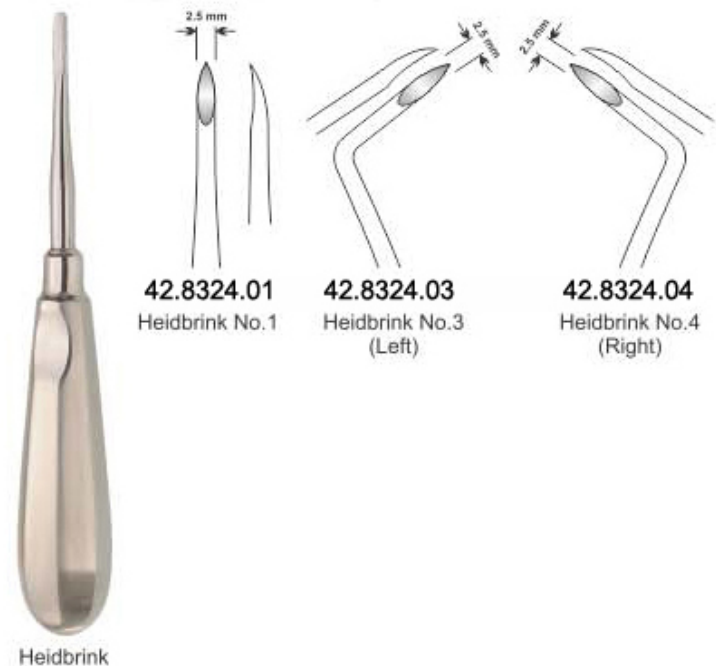

- Элеватор корневой экстракционный
- Elevateurs à racines
- Wurzelheber
- Слеватор корневий екстракційний
- Elevadores para raices
- المضاعد الجذر

**Friedmann Roots Elevator**



42.8325.04 Friedmann 4F Str.  
42.8325.05 Friedmann 5F Left  
42.8325.06 Friedmann 6F Right

**Heidbrink Roots Elevator**



42.8326.01 Heidbrink Straight  
42.8326.03 Heidbrink Left  
42.8326.04 Heidbrink Right

**Wisdom Roots Elevator**



42.8327.18 Wisdom for 18 and 38  
42.8327.48 Wisdom for 28 and 48

**Bayonet Roots Elevator Set**



42.8328.01 Left  
42.8328.02 Right  
42.8328.03 bayonet  
42.8328.04 Curved  
42.8328.05 Straight

**Luxator Roots Elevator**



42.8329.01 Luxator Straight  
42.8329.02 Luxator Curved



- Элеватор корневой экстракционный
- Elévateurs à racines
- Wurzelheber
- Слеватор корневий экстракційний
- Elevadores para raíces
- المصاعد الجذر

### Roots Elevator

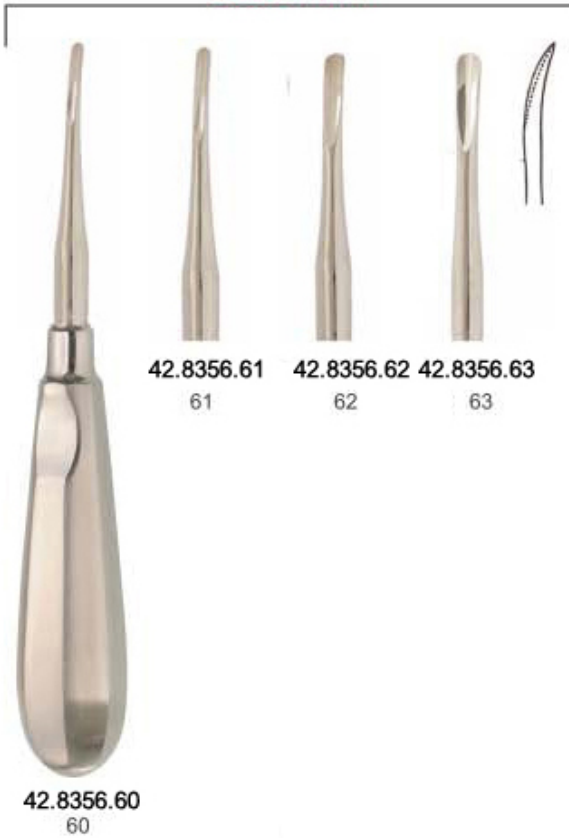

### Luxier Roots Elevator



### Luxier Roots Elevator

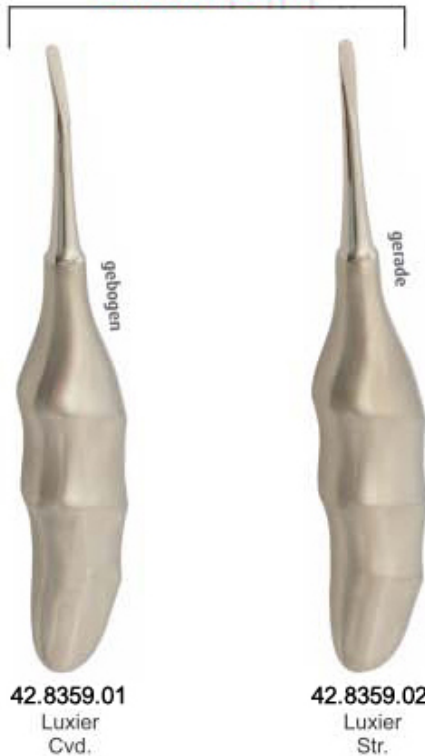

### Claw-Lift Roots Elevator



- Элеватор корневой экстракционный
- Elévateurs à racines
- Wurzelheber
- Слеватор корневий екстракційний
- Elevadores para raices
- المصاعد الجذر

**Hysin Roots Elevator**

**Cryer Roots Elevator**



2.3mm  
20mm

42.8330.01  
Hysin  
Overall length  
154mm

42.8330.02  
Hysin  
3.5mm  
Str.

42.8330.03  
Hysin  
3.5mm  
Left

42.8330.04  
Hysin  
3.5mm  
Right

42.8330.05  
Hysin  
4.5mm  
Str.

42.8330.06  
Hysin  
Overall length  
153mm

4mm  
19mm

42.8331.01  
Cryer  
77  
Right/Left

42.8331.02  
Cryer  
27S  
Left

42.8331.03  
Cryer  
28S  
Right

**Kopp Roots Elevator**

42.8332.01  
1  
KOPP  
3.6mm  
Upper Roots

42.8332.02  
2  
KOPP  
3.6mm  
Upper Roots

42.8332.03  
3  
KOPP  
4.2mm  
Upper Roots

42.8332.04  
4  
KOPP  
4.2mm  
Upper Roots

42.8333.01  
1  
KOPP  
3.6mm  
Lower Roots

42.8333.02  
2  
KOPP  
3.6mm  
Lower Roots

42.8333.03  
3  
KOPP  
4.2mm  
Lower Roots

42.8333.04  
4  
KOPP  
4.2mm  
Lower Roots

- Элеватор корневой экстракционный
- Elévateurs à racines
- Wurzelheber

- Elevator corneviu extracționii
- Elevadores para raíces
- المصاعد الجذر

## Kopp Roots Elevator



42.8334.01  
Kopp  
Right

42.8334.02  
Kopp  
Left

## Heber Roots Elevator



42.8335.01  
Heber  
Bayonet

42.8335.02  
Heber  
Bayonet

## Bein Roots Elevator



42.8336.01  
Bein,  
3mm

42.8336.02  
Bein,  
4mm

## Bein Roots Elevator



42.8337.02  
2mm  
straight  
serrated

42.8337.03  
3mm  
straight

42.8337.04  
4mm  
Curved

42.8338.02  
2mm  
straight  
serrated

42.8338.03  
3mm  
straight

42.8338.04  
4mm  
Curved

42.8339.02  
2mm  
straight  
serrated

42.8339.03  
3mm  
straight

42.8339.04  
4mm  
Curved

42.8337.01  
Bein  
2mm, curved  
serrated

42.8338.01  
Bein  
2mm, curved  
serrated

42.8339.01  
Bein  
2mm, curved  
serrated

- Элеватор корневой экстракционный
  - **Élévateurs à racines**
  - Wurzelheber
- Єлеватор кореневий екстракційний
  - Elevadores para raíces
  - المصاعد الجذر

**Seldin Roots Elevator**



42.8340.27 Cryer 27 (Left)    42.8340.28 Cryer 28 (Right)    42.8341.01 Seldin #1L    42.8341.02 Seldin #1R    42.8341.03 Seldin #4L    42.8341.04 Seldin #4R    42.8342.01 Seldin No.1 (Stout)    42.8342.02 Seldin No.2    42.8343.03 Kopp No.3    42.8343.04 Kopp No.4

**W. Barry Roots Elevator**



42.8344.00 W. Barry 1 (mm 125)    42.8344.01 W. Barry 1    42.8344.02 W. Barry 2    42.8344.03 W. Barry 3    42.8344.04 W. Barry 4

**Winter Roots Elevator**



42.8345.01 Winter 1L (mm 125)    42.8345.02 Winter 1L    42.8345.03 Winter 1R    42.8345.04 Winter 11L    42.8345.05 Winter 11R    42.8345.06 Winter 12L    42.8345.07 Winter 12R

**Pott Roots Elevator**



42.8346.01 Lecluse bayonet    42.8347.01 Pott Left    42.8347.02 Pott Right

- Элеватор корневой экстракционный
- **Élévateurs à racines**
- Wurzelheber

- Єлеватор коренвий екстракційний
- Elevadores para raíces
- المصاعد الجذر

#### Heidbrink Roots Elevator



42.8348.01 Heidbrink Straight  
 42.8348.02 Heidbrink Left  
 42.8348.03 Heidbrink Right

42.8349.01 Heidbrink Straight  
 42.8349.02 Heidbrink Left  
 42.8349.03 Heidbrink Right

#### Syndesmotomes Roots Elevator



42.8350.01 Straight  
 42.8350.02 Left  
 42.8350.03 Right

Syndesmotomes

#### Periotome Roots Elevator



42.8351.01 Periotome 2.1mm Straight  
 42.8351.02 Periotome 2.6mm Straight  
 42.8351.03 Periotome 2.1mm Angular  
 42.8351.04 Periotome 2mm Curved

42.8351.05 Periotome 2.0mm  
 42.8351.06 Periotome 2.5mm  
 42.8351.07 Periotome 3.0mm  
 42.8351.08 Periotome 4.0mm

- Элеватор корневой экстракционный
- Elévateurs à racines
- Wurzelheber
- Елеватор корневий екстракційний
- Elevadores para raices
- المعصاع الجذر



**42.8352.01**  
1S  
(Straight 1mm)



**42.8352.02**  
2S  
(Straight 2mm)



**42.8352.03**  
3S  
(Straight 3mm)



**42.8352.04**  
5S  
(Straight 5mm)



**42.8352.05**  
3C  
(Curved 3mm)



**42.8352.06**  
5C  
(Curved 5mm)



**42.8352.07**  
3CA  
(Curved Angle 3mm)



**42.8352.08**  
3IC  
(Inverted Curved 3mm)



**42.8353.01**  
DE 3  
(Dual Edge 3mm / 1.5mm)



**42.8353.02**  
DE 5  
(Dual Edge 5mm / 3mm)



- Элеватор корневой экстракционный
- Élévateurs à racines
- Wurzelheber

- Єлеватор кореневий екстракційний
- Elevadores para raices
- المصاعد الجذر

**PDL ELEVATORS**



**42.8354.07**  
 PDL Elevators  
 Set of 7 Pcs



**42.8355.07**  
 PDL Elevators  
 Set of 7 Pcs

- Элеватор корневой экстракционный
- Elévateurs à racines
- Wurzelheber
- Слеватор кореневий екстракційний
- Elevadores para raíces
- المصاعد الجذر

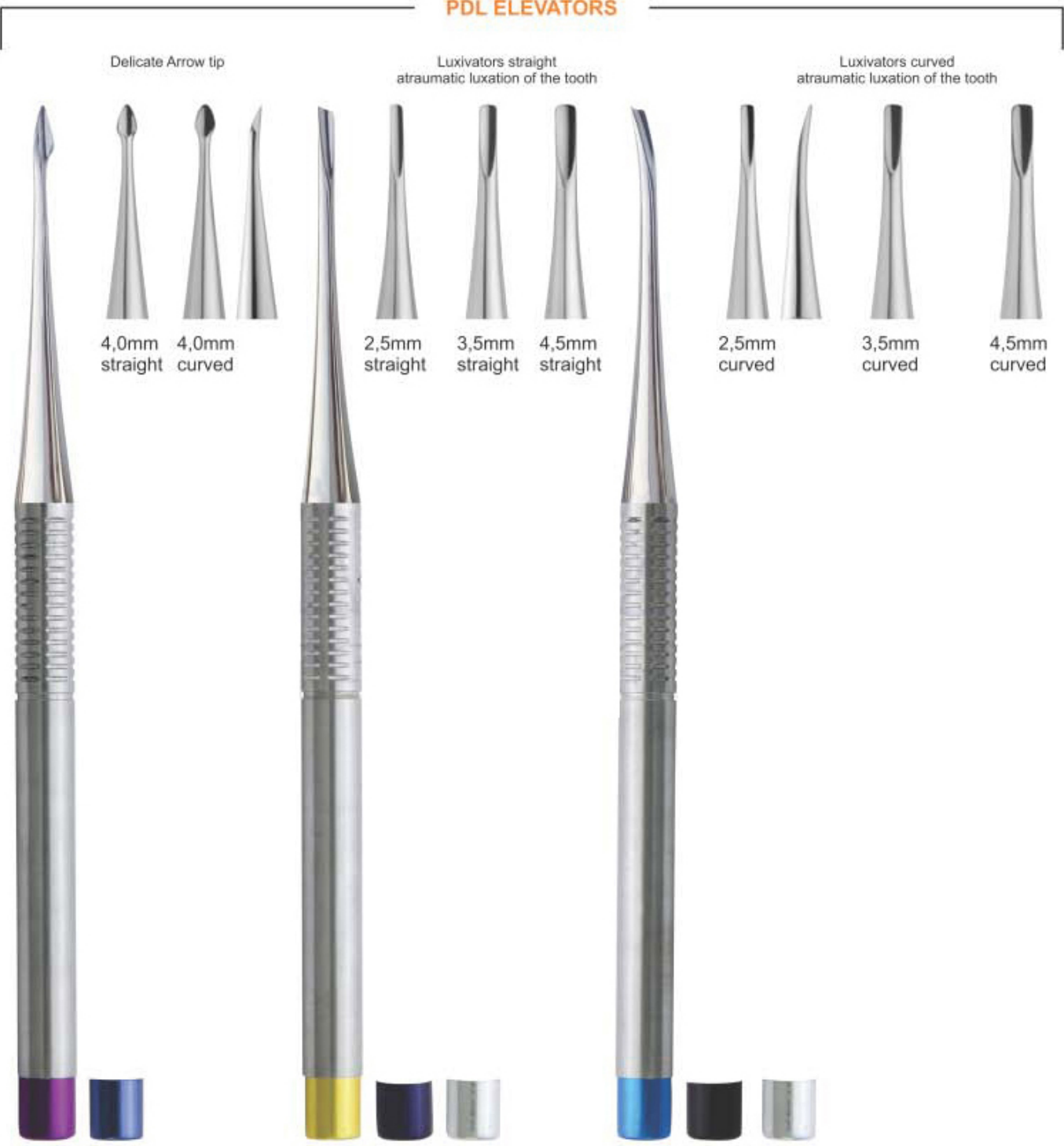
**PDL ELEVATORS**



Delicate Arrow tip



4,0mm straight 4,0mm curved

Luxivators straight atraumatic luxation of the tooth



2,5mm straight 3,5mm straight 4,5mm straight

Luxivators curved atraumatic luxation of the tooth



2,5mm curved 3,5mm curved 4,5mm curved

**42.8356.08**  
PDL Elevators  
Set of 8 Pcs

## Our Scalars

Compare our scalars and curettes with the best in the industry and you will immediately recognize we are equal in every way but one... price. Note the deep precision knurling for better tactile feel. The same high-grade stainless steel tips, the same light weight (under 18 grams) for less hand fatigue, the same professional craftsmanship, and surpassing the highest industry standards. of course, any manufacturer can make these claims, but we guarantee and certify ours.

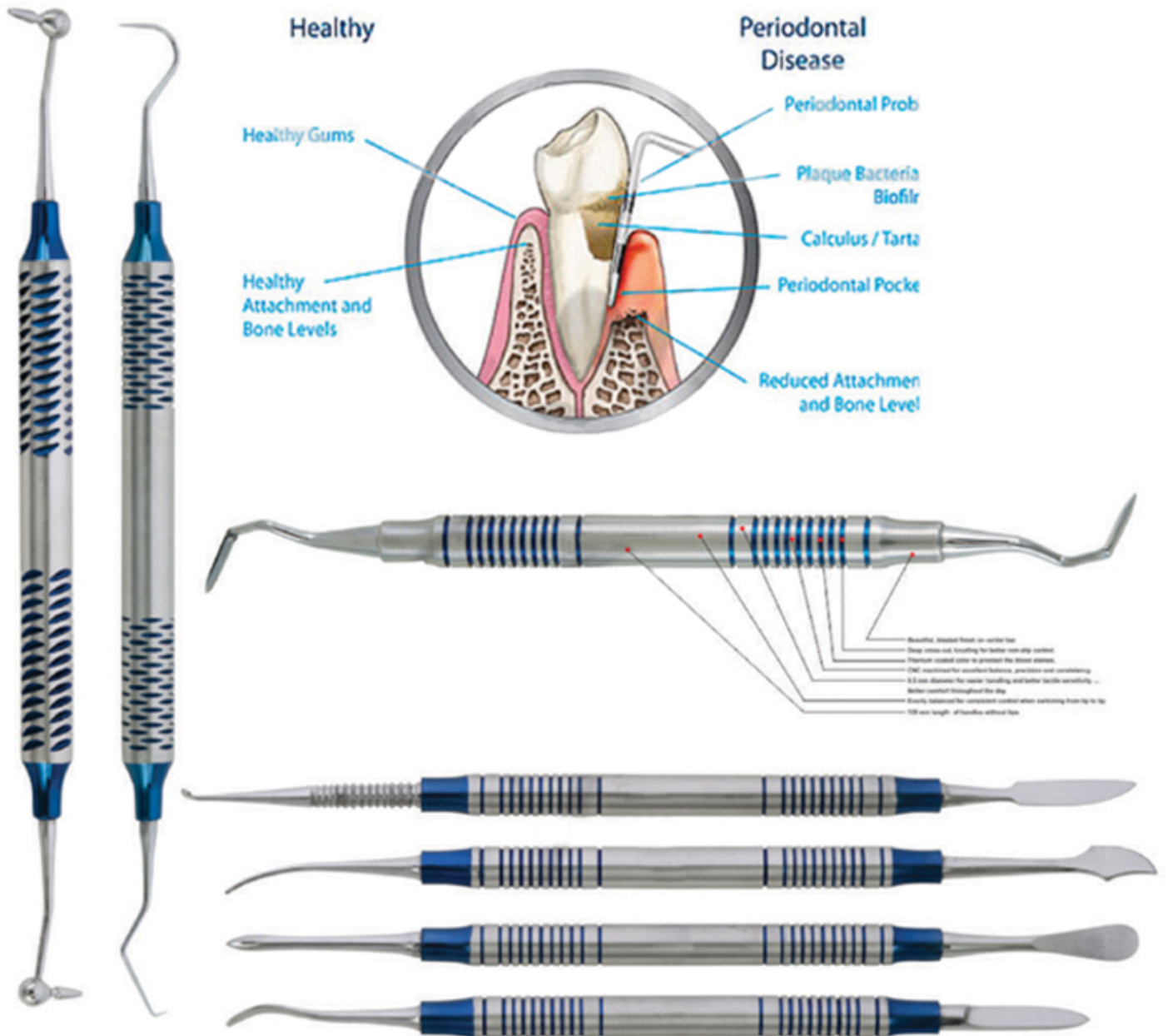

- High-polish mirror finish tips.
- Manufactured within the guidelines of the FDA quality assurance system for good manufacturing practices.
- Highest grade German stainless steel, razor sharp, durable tips. Rockwell hardened to 60 RHc.
- 27 of the most popular designs from graceys to McCalls to columbias, and many european patterns.
- All instruments are guaranteed against defects in material and workmanship.

- All instruments bear the ce mark, emblematic of the european community's highest standards.
- Customer satisfaction guarantee, too!
- Less than 20 grams ... Lightweight for less hand fatigue.
- Manufactured to the most exacting standards so the 50th instrument you buy is exactly like your first.
- You decide ... Why pay more for the same high-quality instruments?

- Ручки для зеркал
- Manches pour miroirs à bouche
- Mundspiegelgriffe
- Ручки для дзеркал
- Mangos para espejos de boca
- مقابض لمرآيا الفم



Magnifying

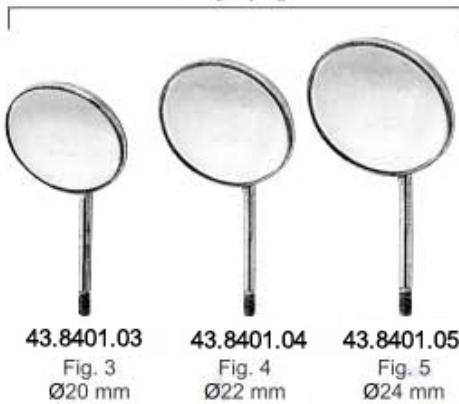

Plain

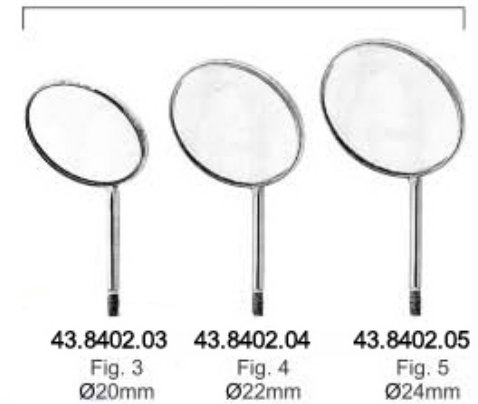

Rhodium

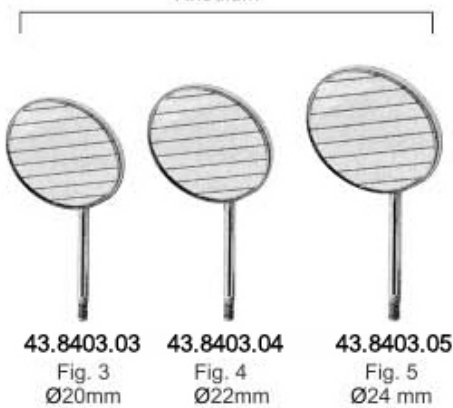

43.8404.01 Hollow Mirror Handle Stem Extra Light (7.5mm) Length 5"



43.8404.02 Mirror Handle Stem Octagonal (6mm) Length 5"



43.8404.03 Mirror Handle Stem Round (6mm) Length 5"



13.8404.04 Solid 12cm



43.8404.05 Solid



43.8404.06 Mirror Handle Stem with Rule 35mm (6mm) Length 5"



43.8404.07 Mirror Handle Stem with Rule 35mm (6mm) Length 5"



- Пинцеты
- Précelles - Brucelles
- Zahnpinzetten

- Пинцети
- Pinzas para algodón
- ملاقط



43.8405.11  
Surgical  
11.5cm



43.8406.15  
London College  
15cm



43.8407.01  
Semken Taylor  
Str.



43.8407.02  
Semken Taylor  
Cvd.



43.8408.16  
Meriam  
16cm



43.8409.14  
Dressing  
14cm



43.8410.01  
Semken Taylor  
1x2 Straight



43.8410.02  
Semken Taylor  
1x2 Curved



43.8411.15  
Gilles  
15cm 1x2



43.8412.14  
14cm 1x2



43.8413.13  
Perry  
13cm



43.8414.01  
Atraumatic  
15cm Cvd



43.8414.02  
Atraumatic  
15cm Str.



43.8415.15  
College with Lock  
15cm Cvd.



43.8416.17  
Gerald  
17.5cm



43.8417.15  
with lock  
15cm



43.8414.17  
Atraumatic  
17.5cm

- Пинцеты
- Précelles - Brucelles
- Zahnpinzetten

- Пінцети
- Pinzas para algodón
- ملاقط



**43.8418.01**  
Adson-TC  
12cm



**43.8418.02**  
Adson-TC  
12cm 1x2



**43.8418.03**  
Adson-TC  
15cm 1x2



**43.8419.01**  
Adson  
12cm



**43.8419.02**  
Adson  
12cm 1x2



**43.8419.03**  
Adson  
15cm 1x2



**43.8420.12**  
Adson Brown  
12cm



**43.8421.15**  
Crane Kaplan  
15cm



**43.8422.01**  
Crane Kaplan  
15cm



**43.8422.02**  
Crane Kaplan  
15cm



**43.8423.15**  
Hemingway  
15cm



**43.8424.01**  
Miller  
15cm Str.



**43.8424.02**  
Miller  
15cm Cvd.



**43.8425.14**  
Dressing  
Tweezer  
14.5cm



**43.8426.15**  
College  
Curved  
Tip 15cm



**43.8427.15**  
Maryam  
Tweezers  
15cm



**43.8428.15**  
College  
Tweezer  
15cm



**43.8429.12**  
Perry  
Tweezer  
12.5cm



**43.8430.15**  
Self-locking  
Tweezer  
15cm

- Зонды
  - Sondes
  - Zahnsonden
- Зонди
  - Sondas
  - المستكشفين

Single Ended Probe Solid Handle 4.5mm Length 150mm

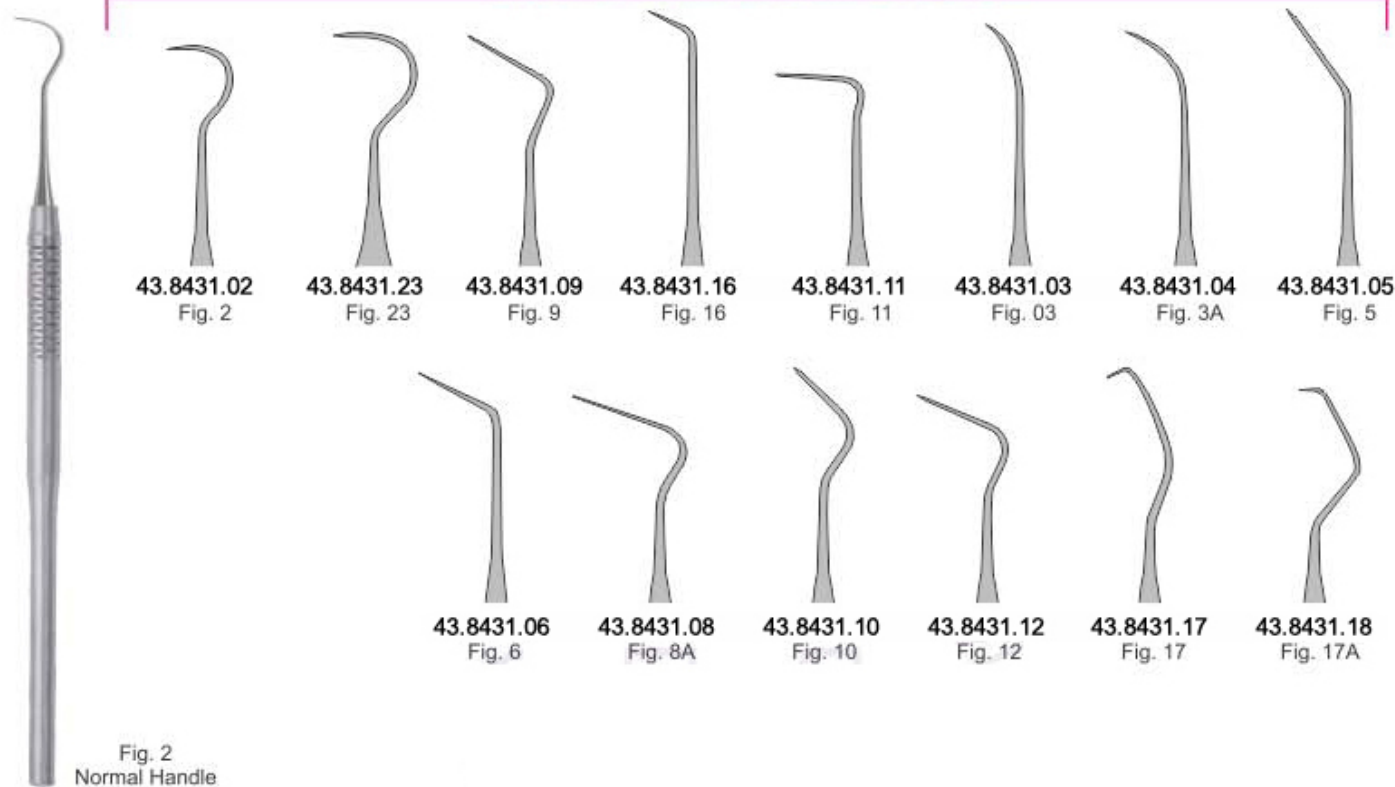

Single Ended Probe Hollow Handle 8.5mm Length 150mm

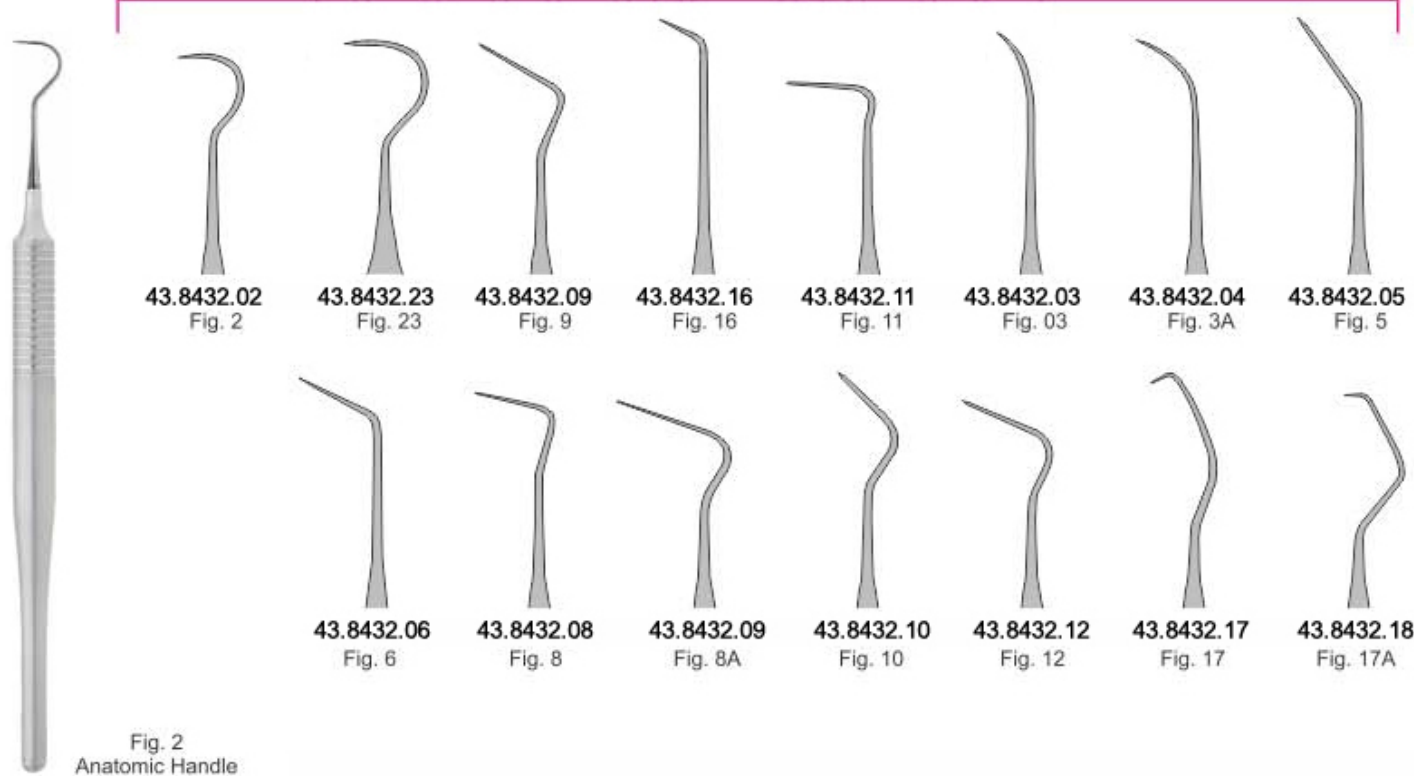

- Зонды
- Sondes
- Zahnsonden
- Зонди
- Sondas
- المستكشفين

Probes Single End Solid Handle 6mm, length 150mm

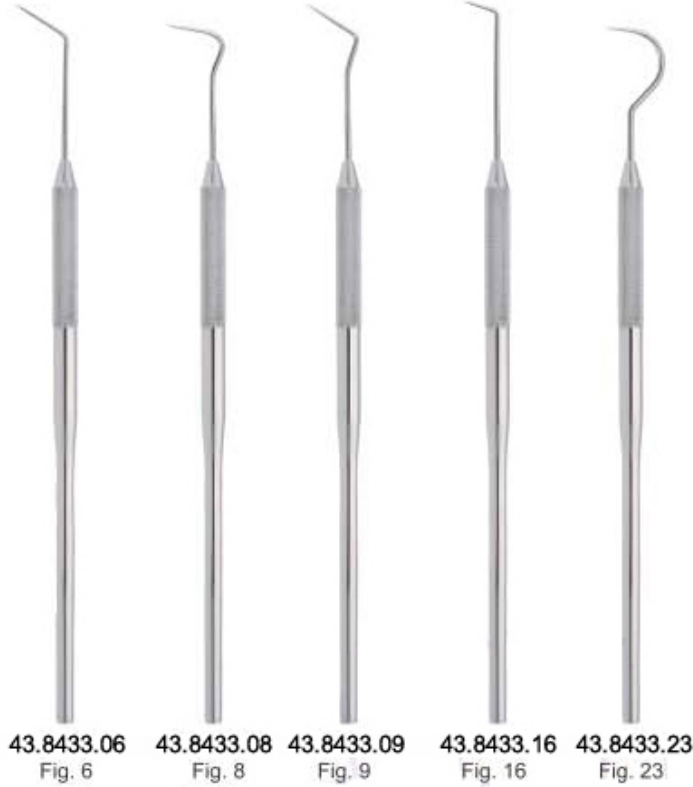

Probes Single Ended 6mm, length 150mm



Examination kit Set of 3 Pieces



Examination Set of 4 Pieces



Examination Set of 4 Pieces





- Зонды
  - Sondes
  - Zahnsonden
- Зонди
  - Sondas
  - المستكشفين

**EXPLORERS INSTRUMENTS  
SOLID HANDLE 6MM, LENGTH 170MM**

Explorers-Single-End



**43.8438.23**  
23  
Shepherd's  
Hook  
Explorer  
#30, #6, #7, #8

Double-Ended Explorers

Tip Size: 1/1

Solid Handle Size 4.25"

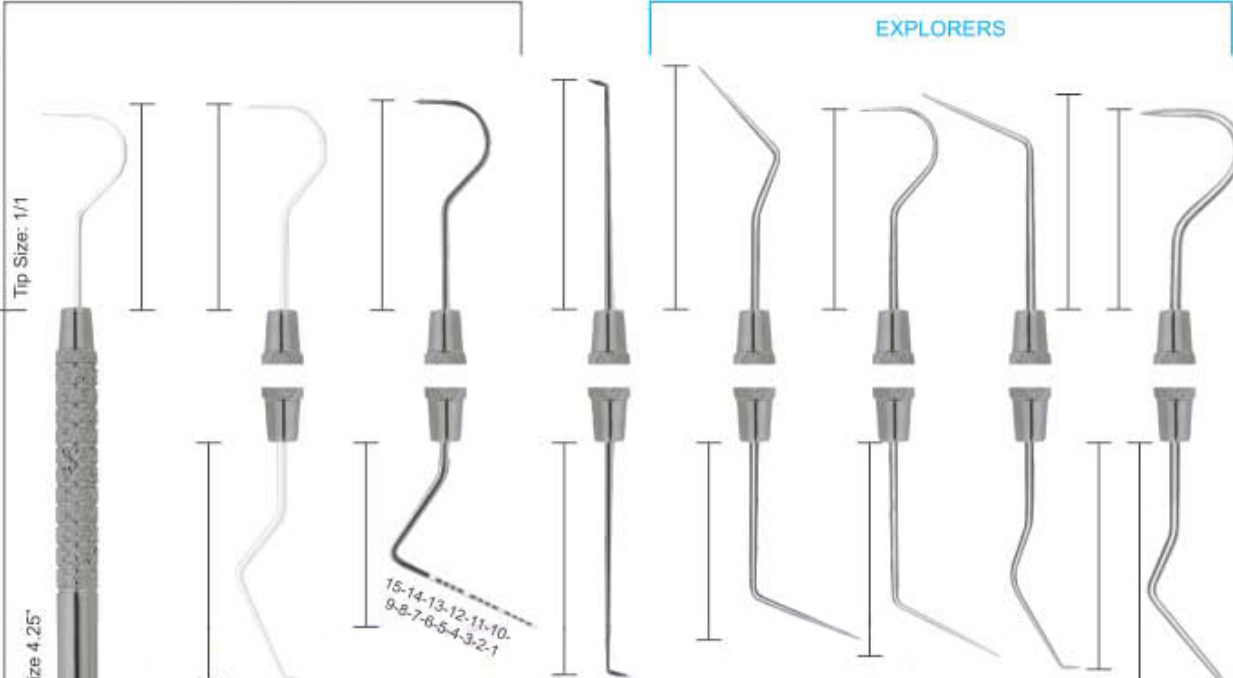





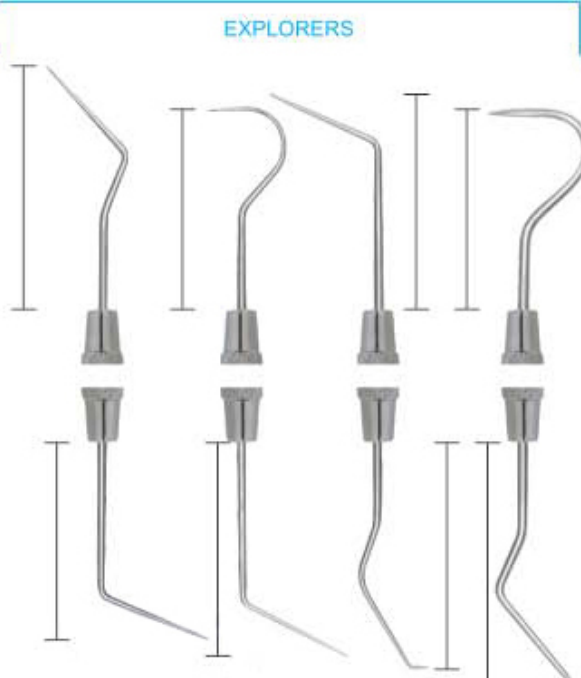

15-14-13-12-11-10-9-8-7-6-5-4-3-2-1

<b>43.8439.01</b> TU 17/23 Wilkins/Tufts Explorer #6	<b>43.8439.02</b> 23/UNC1 university of north carolina Explorer #31, #6, #7, #8	<b>43.8439.03</b> 1 #31, #6	<b>43.8439.04</b> DG 16 #31, #6, #7 Thick, #6	<b>43.8439.05</b> DG 16/23	<b>43.8439.06</b> DG 16/17	<b>43.8439.07</b> 1 Abou-Rass Explorers
--	---	-----------------------------------	--	-------------------------------	-------------------------------	--

EXPLORERS



Probes Double Ended 6mm, length 170mm

					
<b>43.8440.01</b> Goldman Fox Fig.17	<b>43.8440.02</b> University of Michigan Fig.17	<b>43.8440.03</b> Williams Fig.17	<b>43.8440.04</b> Goldman Fox Fig.16	<b>43.8440.05</b> University of Michigan Fig.16	<b>43.8440.06</b> Williams Fig.16

- Зонды
  - Sondes
  - Zahnsonden
- Зонди
  - Sondas
  - المستكشفين

Pointed Probes Single Ended Handle 6mm, length 150mm

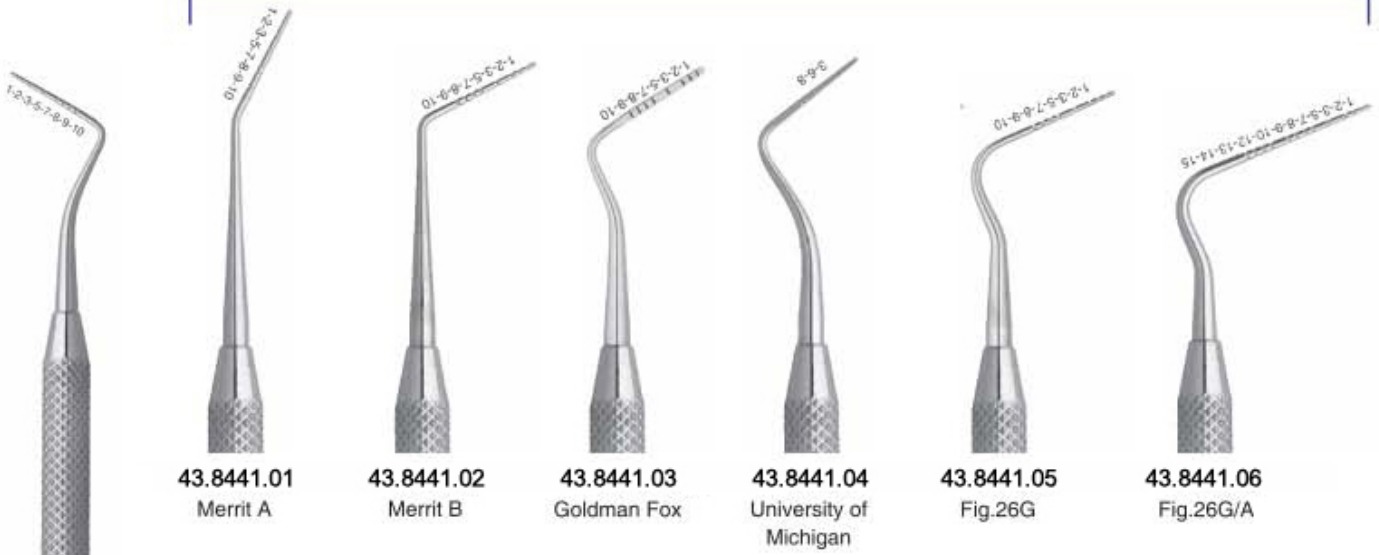

Pointed Probes Double Ended Handle 6mm, length 170mm



- Инструменты пародонтологические
- Instruments pour la parodontologie
- Instrumente für die Parodontologie

- Інструменти пародонтологічні
- instrumentos para periodoncia
- المسكوك اللثة

**PERIODONTAL SET OF 10 PIECES SOLID HANDLE 6MM LENGTH 170MM**

- Зонды
- Sondes
- Zahnsonden
- Зонди
- Sondas
- المستكشفين

**WILLIAM PROBE SET DOUBLE ENDED WITH HOLLOW HANDLE 9.5MM, LENGTH 170MM  
CERAMIC COATED HANDLE**

Proper care must be given during cleaning, sharpening and sterilization to preserve design and integrity and to prolong usefulness. Do not expose instruments to sterilization temperatures above 350 F/177 C or to higher than recommended chemical concentrations.

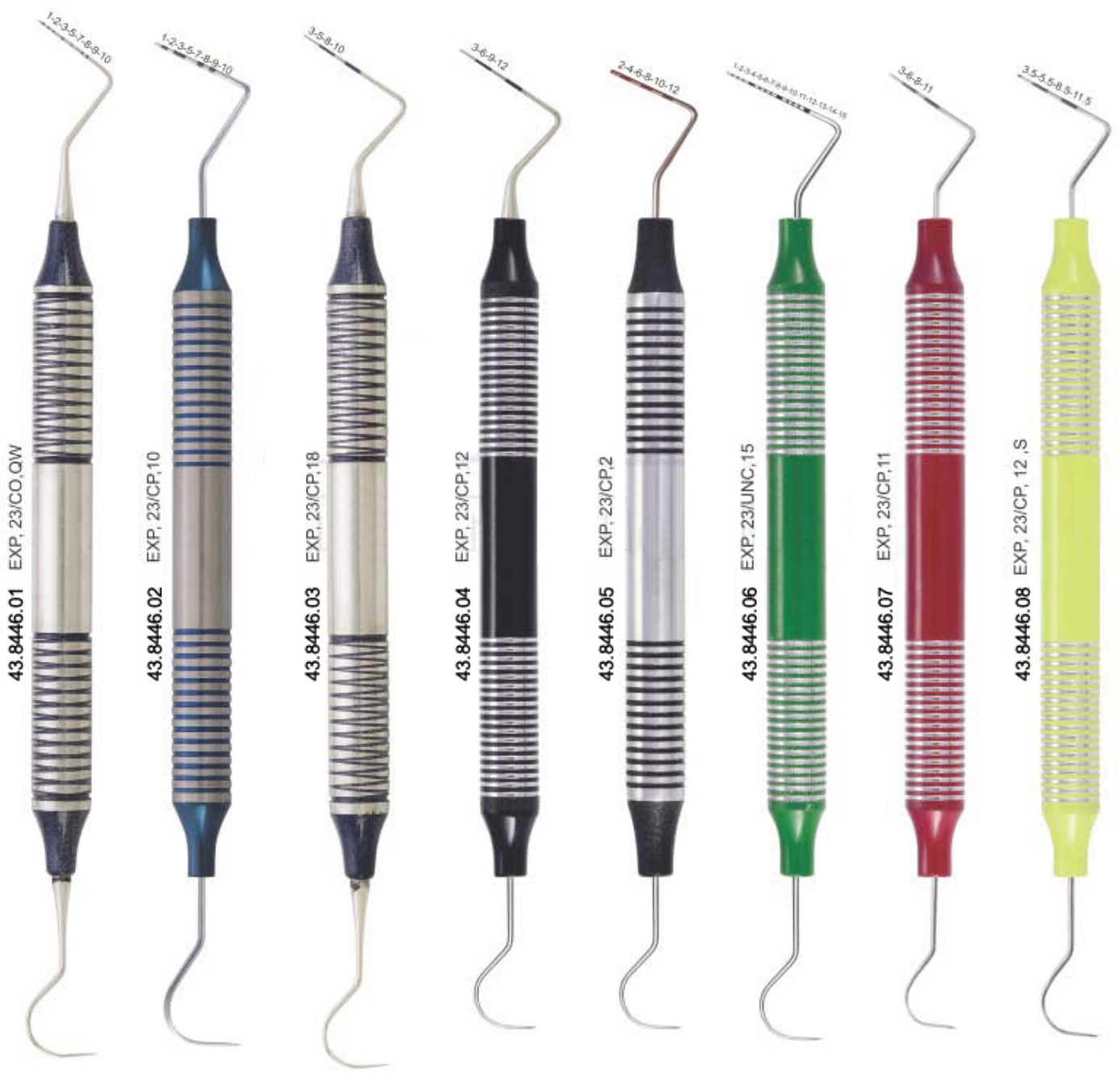

- Инструменты пародонтологические
- Instruments pour la parodontologie
- Instrumente für die Parodontologie

- Інструменти пародонтологічні
- Instrumentos para periodoncia
- الصكوك اللثة

**PERIODONTAL INSTRUMENTS SET OF 11 PCS  
SOLID HANDLE 6MM, LENGTH 170MM**



- Кюрети
- Curetas
- Küretten
- Кюрети
- Curette
- کرتس

**GRACEY SET OF 7 PCS HOLLOW HANDLE 9.5MM, LENGTH 170MM**

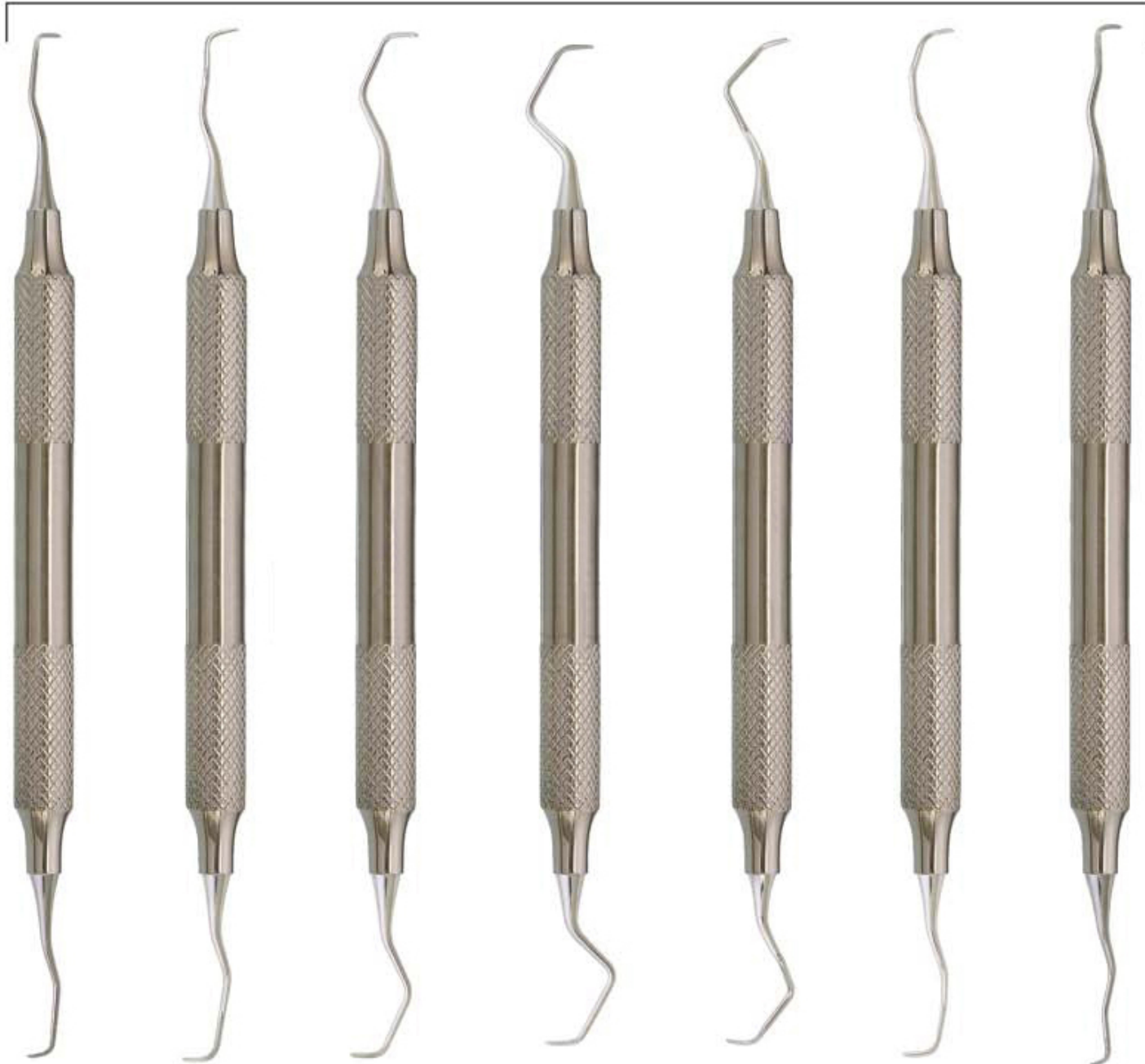

43.8458.12  
GRACEY  
1/2

43.8458.34  
GRACEY  
3/4

43.8458.56  
GRACEY  
5/6

43.8458.78  
GRACEY  
7/8

43.8458.91  
GRACEY  
9/10

43.8458.92  
GRACEY  
11/12

43.8458.93  
GRACEY  
13/14

- Кюрети
- Curetas
- Küretten

- Кюрети
- Curette
- كرتس

**GRACEY SET OF 7 PCS**  
**HOLLOW HANDLE 9.5MM, LENGTH 170MM WITH SILICON GRIP**

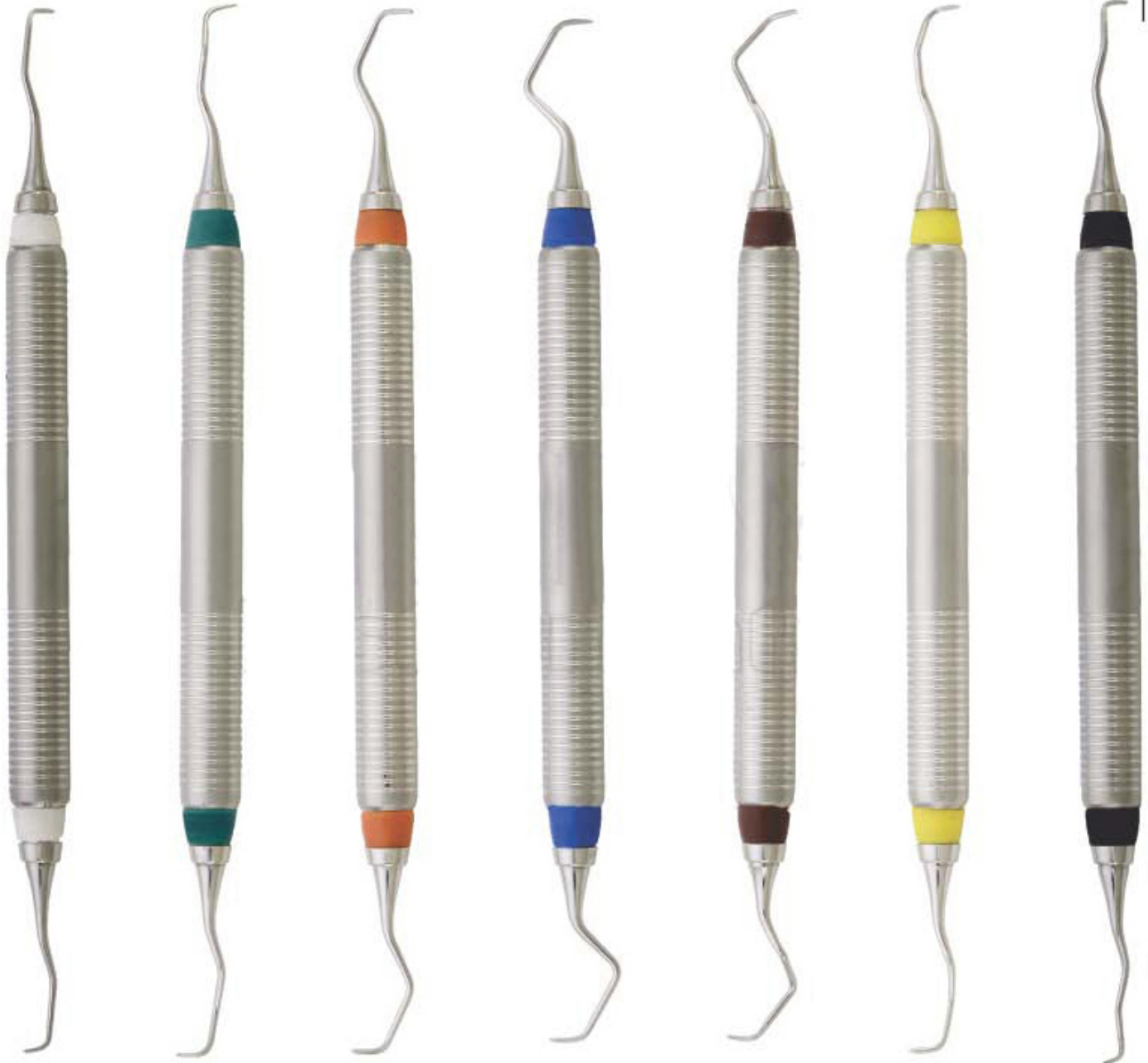

43.8459.12  
 GRACEY  
 1/2

43.8459.34  
 GRACEY  
 3/4

43.8459.56  
 GRACEY  
 5/6

43.8459.78  
 GRACEY  
 7/8

43.8459.91  
 GRACEY  
 9/10

43.8459.92  
 GRACEY  
 11/12

43.8459.93  
 GRACEY  
 13/14

- Кюрети
  - Curetas
  - Küretten
- Кюрети
  - Curette
  - كرتس

**GRACEY MINI FIVE**  
HOLLOW HANDLE 9.5MM, LENGTH 170MM  
CERAMIC COATED HANDLE

**GRACEY AFTER FIVE**  
HOLLOW HANDLE 9.5MM, LENGTH 170MM  
CERAMIC COATED HANDLE

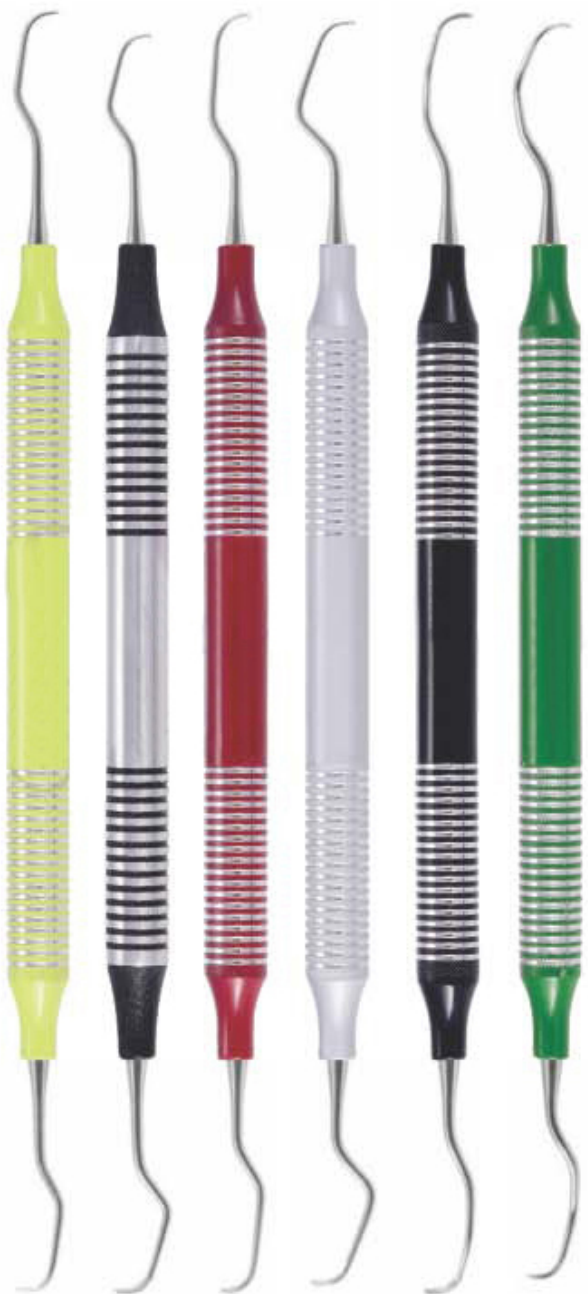
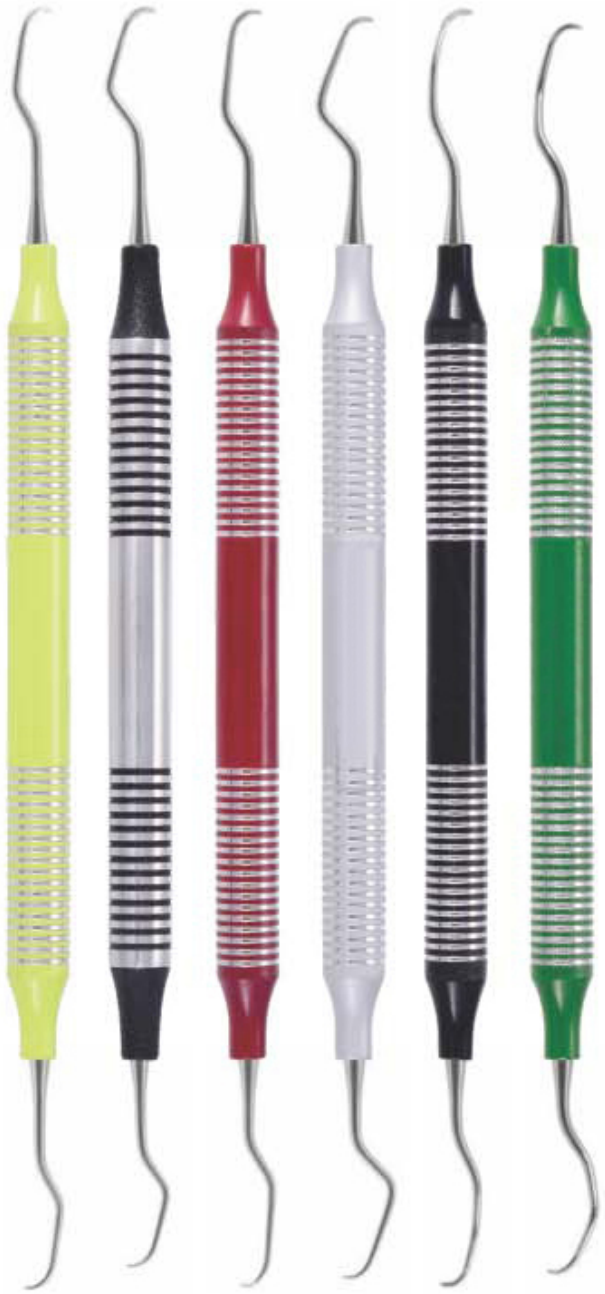

43.8460.12 Gracey 1/2  
43.8460.34 Gracey 3/4  
43.8460.56 Gracey 5/6  
43.8460.78 Gracey 7/8  
43.8460.92 Gracey 11/12  
43.8460.93 Gracey 13/14

43.8461.12 Gracey 1/2 AF  
43.8461.34 Gracey 3/4 AF  
43.8461.56 Gracey 5/6 AF  
43.8461.78 Gracey 7/8 AF  
43.8461.92 Gracey 11/12 AF  
43.8461.93 Gracey 13/14 AF

Proper care must be given during cleaning, sharpening and sterilization to preserve design and integrity and to prolong usefulness. Do not expose instruments to sterilization temperatures above 350 F/177 C or to higher than recommended chemical concentrations.



- Кюрети
- Curetas
- Küretten

- Кюрети
- Curette
- كرتس

**GRACEY CURETTE  
HOLLOW HANDLE 10MM, LENGTH 170MM**

Curetters Set of 8 Pieces

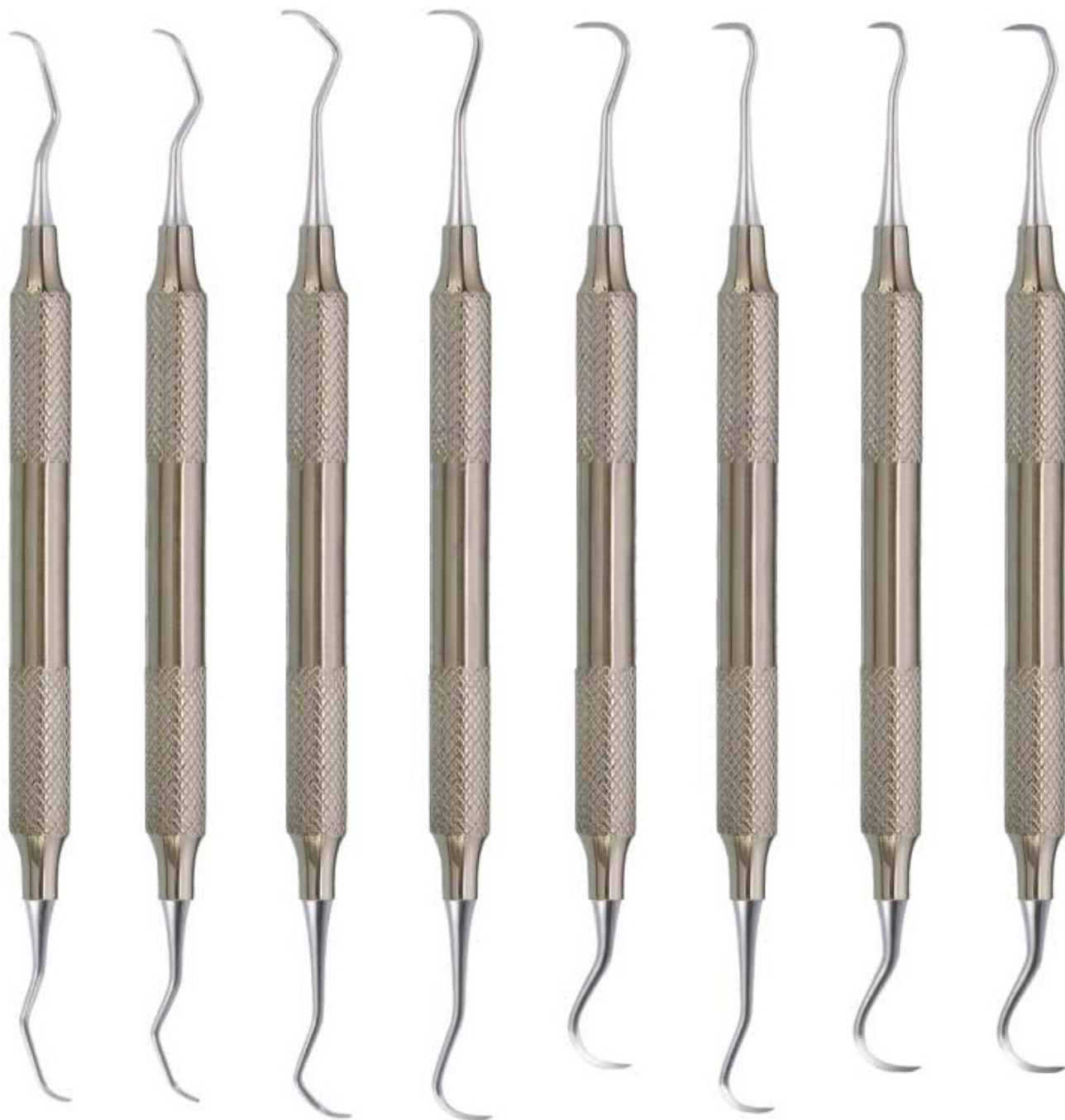

**43.8462.01**  
Curette  
Columbia  
2L-2R

**43.8462.02**  
Curette  
Columbia  
4L-4R

**43.8462.03**  
Curette  
McCall  
13S-14S

**43.8463.01**  
H6-H7  
Scaler  
Sickle

**43.8463.02**  
H5-U15  
Scaler  
Sickle

**43.8463.03**  
H5-13  
Scaler  
Sickle

**43.8463.04**  
U15-30  
Scaler  
Sickle

**43.8463.05**  
U15-33  
Scaler  
Sickle

- Инструменты для реставрации
- Instruments pour plombage
- Füllungsinstrumente (mit Kontrawinkel)

- Инструменти для реставрації
- Instrumentos para obturaciones
- ملء الصكوك

**FILLING INSTRUMENTS (Gold Pointed)  
SOLID HANDLE 6MM, LENGTH 170MM**



**Filling instrument, spatula 6 mm solid handle, length 170 mm,**

**Filling instrument 6 mm length 175 mm,**

**Filling instrument, ball 6 mm length 170 mm,**

**Filling instrument, ball / spatula 6 mm length 175 mm,**

**Filling instrument, plan / plan 6 mm length 165 mm,**

**EXPLORERS INSTRUMENTS**  
SOLID HANDLE 6MM, LENGTH 170MM

- Зонды
- Sondes
- Zahnsonden
- Зонди
- Sondas
- المستكشفين

**PLUGGERS**

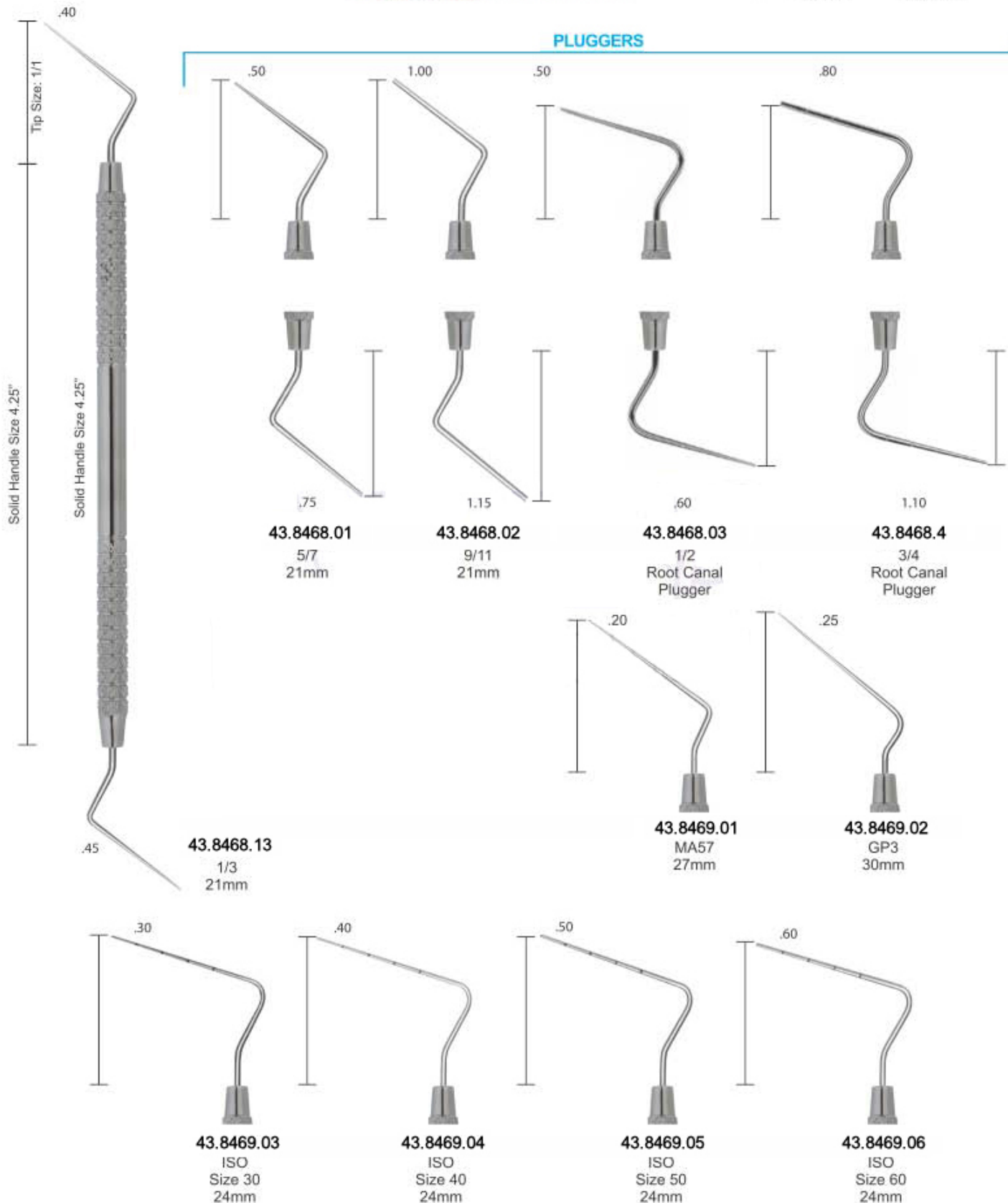

- Зонды пародонтологические
- Sondes parodontales
- sonde parodontali
- зонди пародонтологичн
- Sondas parodontales
- المسابر اللثة



**SPREADERS**

**HEAT CARRIERS**

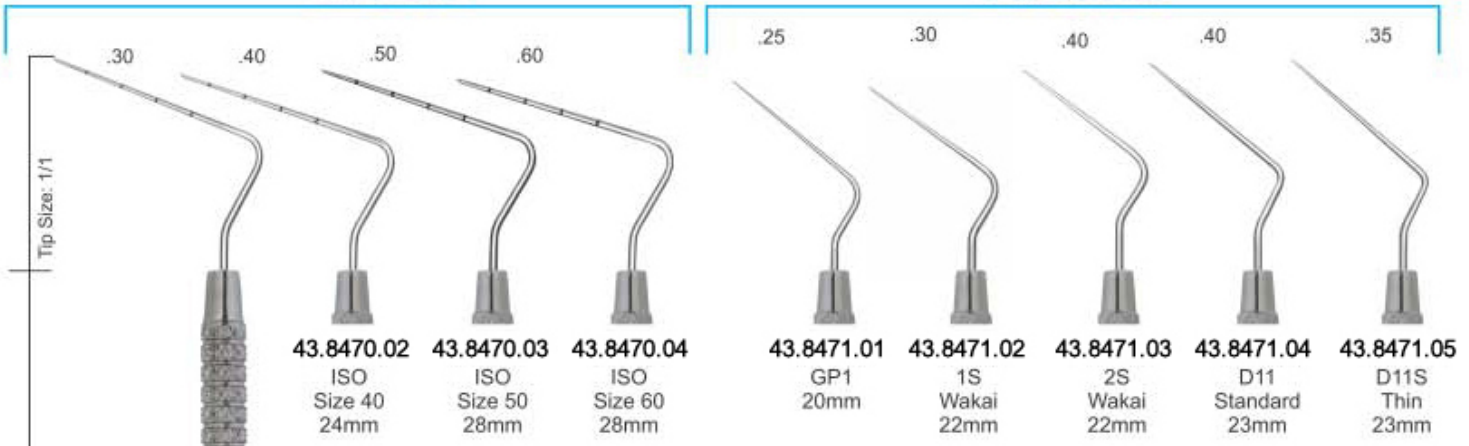

**HEAT CARRIERS**

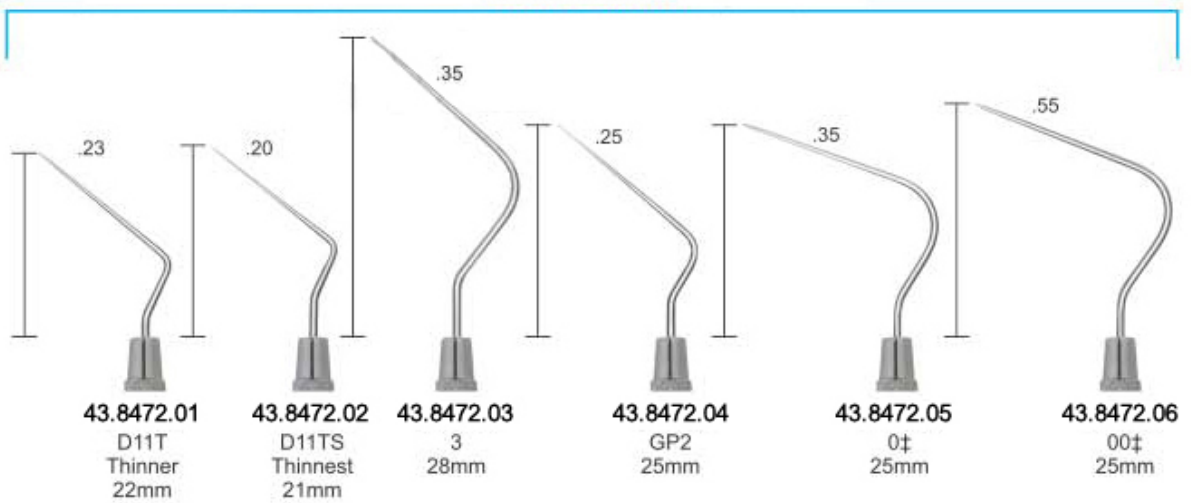

**43.8470.01**  
ISO  
Size 30  
24mm

Tip Size: 1/1

Solid Handle Size 4.25"

- Зонды пародонтологические
- Sondes parodontales
- sonda parodontali
- зонди пародонтологічні
- Sondas parodontales
- المسابر اللثة

ENDODONTICS INSTRUMENTS

ANTERIOR



**43.8473.01**  
8A  
29mm

**43.8473.02**  
8 1/2A  
29mm

**43.8473.03**  
9A  
29mm

**43.8473.04**  
9 1/2A  
29mm

**43.8473.05**  
10A  
29mm

**43.8473.06**  
10 1/2A  
29mm

**43.8473.07**  
11A  
29mm

**43.8473.08**  
11 1/2A  
29mm

**43.8473.09**  
12A  
29mm

LUKS



**43.8474.01**  
L1  
18mm

**43.8474.02**  
L2  
18mm

**43.8474.03**  
L3  
18mm

**43.8474.04**  
L4  
18mm

- Зонды пародонтологические
- Sondes parodontales
- sonda parodontali
- یدی پارودنتولوژیچی
- sondas parodontales
- المسابر اللثة

**ENDODONTICS INSTRUMENTS SOLID HANDLE 6MM, LENGTH 170MM**  
**POSTERIOR**

**RETRO FILLING PLUGGERS**



Tip Size: 1/1 Solid Handle Size 5"	.40  43.8475.01 8 22mm	.45  43.8475.02 8 1/2 22mm	.55  43.8475.03 9 22mm	.65  43.8475.04 9 1/2 22mm	.75  43.8475.05 10 22mm
	.90  43.8475.06 10 1/2 22mm	1.05  43.8475.07 11 22mm	1.15  43.8475.08 11 1/2 22mm	1.30  43.8475.09 12 22mm	

.80  43.8476.02 1	1.10  43.8476.03 2
----------------------------	-----------------------------

Tip Size: 1/1

1.10

Solid Handle Size 4.25"

43.8476.01  
1 Glick  
Blade/  
Pluggers  
#41, #6, #7

- Инструменты для реставрации
- Instruments pour plombage
- Füllungsinstrumente (mit Kontrawinkel)

- Инструменти для реставрації
- Instrumentos para obturaciones
- ملء الصكوك

COMPOSITE/PLASTIC FILLING INSTRUMENTS SOLID HANDLE 6MM, LENGTH 170MM

POSTERIOR

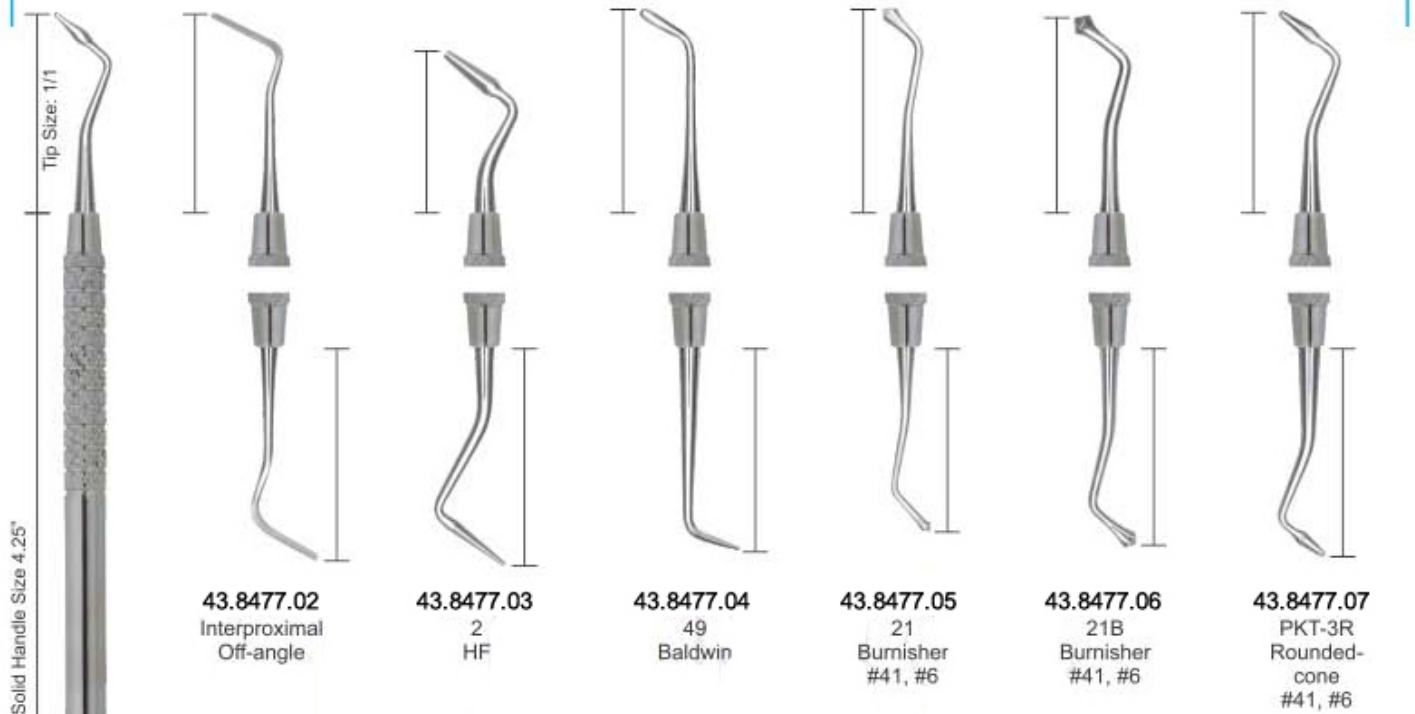

UNIVERSAL FILLING INSTRUMENTS

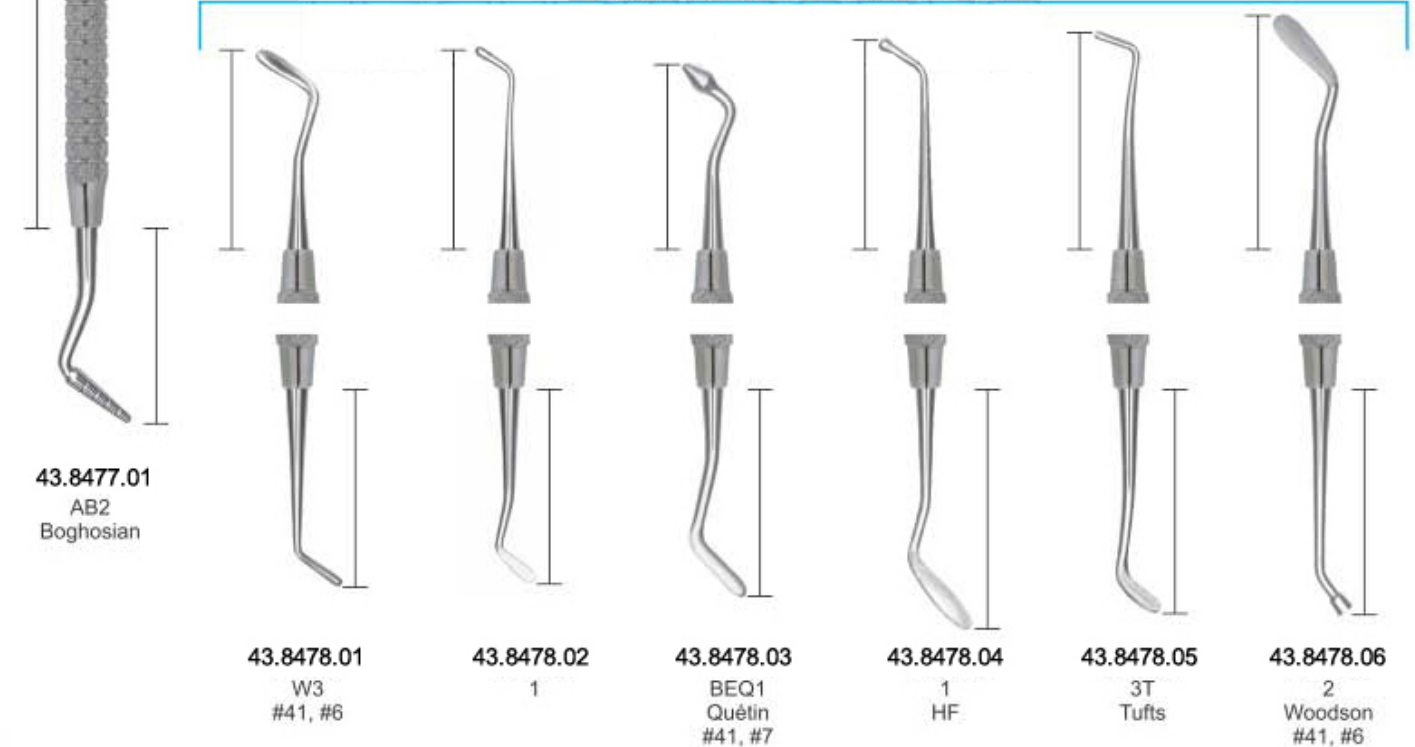

- Инструменты для реставрации
  - Instruments pour plombage
  - Füllungsinstrumente (mit Kontrawinkel)
- Инструменты для реставрації
  - Instrumentos para obturaciones
  - ملء الصكوك

**COMPOSITE/PLASTIC FILLING INSTRUMENTS SOLID HANDLE 6MM, LENGTH 170MM**



BLACK	PLUGGERS/CONDENSERS		Hollenback			
<p>Tip Size: 1.4 Solid Handle Size 4.25"</p>	<p>1.5</p>	<p>1.5</p>	<p>1.0</p>	<p>2.0</p>	<p>2.5</p>	<p>1.8</p>
<p>2.0</p>	<p>2.5</p>	<p>2.5</p>	<p>1.65</p>	<p>2.7</p>	<p>2.5</p>	<p>2.4</p>
<p><b>43.8479.01</b> 1/2 Andrews</p>	<p><b>43.8479.02</b> 1/2 Black (15-7-12) (25-7-12) #41, #6</p>	<p><b>43.8479.03</b> 1/2 Serrated #41, #6</p>	<p><b>43.8480.01</b> H1 Hollenback #41, #6</p>	<p><b>43.8480.02</b> H2 Hollenback #41, #6</p>	<p><b>43.8480.03</b> H3 Hollenback</p>	<p><b>43.8480.04</b> H4 Hollenback</p>
<p><b>MARQUETTE CONDENSER</b></p>			<p><b>MORTONSON</b></p>			
<p>1.0</p>	<p>1.0</p>	<p>0.6</p>	<p>1.0</p>	<p>0.6</p>		
<p>1.4</p>	<p>1.4</p>	<p>1.2</p>	<p>1.5</p>	<p>0.7</p>		
<p><b>43.8481.01</b> 0/1 Marquette Condenser #41, #6</p>	<p><b>43.8481.02</b> 0/1 Marquette #41, #6</p>	<p><b>43.8482.01</b> 2 Mortonson</p>	<p><b>43.8482.03</b> 2 Smith Serrated</p>	<p><b>43.8482.04</b> SPO Serrated</p>		



- Инструменты для реставрации
- Инструменти для реставрації
- Instruments pour plombage
- Instrumentos para obturaciones
- Füllungsinstrumente (mit Kontrawinkel)
- ملء الصكوك

PLUGGERS/CONDENSERS

RESTORATIVE INSTRUMENTS SOLID HANDLE 6MM, LENGTH 170MM

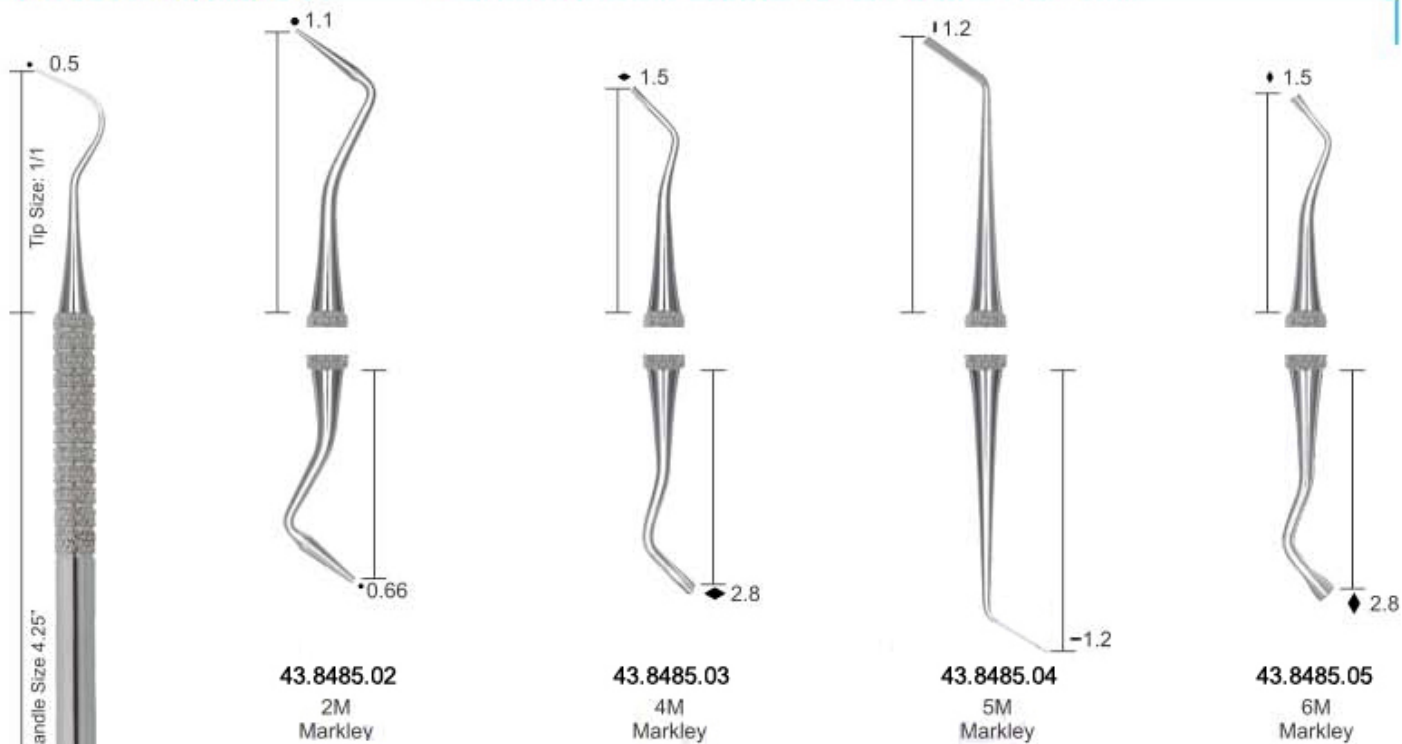

43.8485.02  
2M  
Markley

43.8485.03  
4M  
Markley

43.8485.04  
5M  
Markley

43.8485.05  
6M  
Markley

PLUGGERS/CONDENSERS

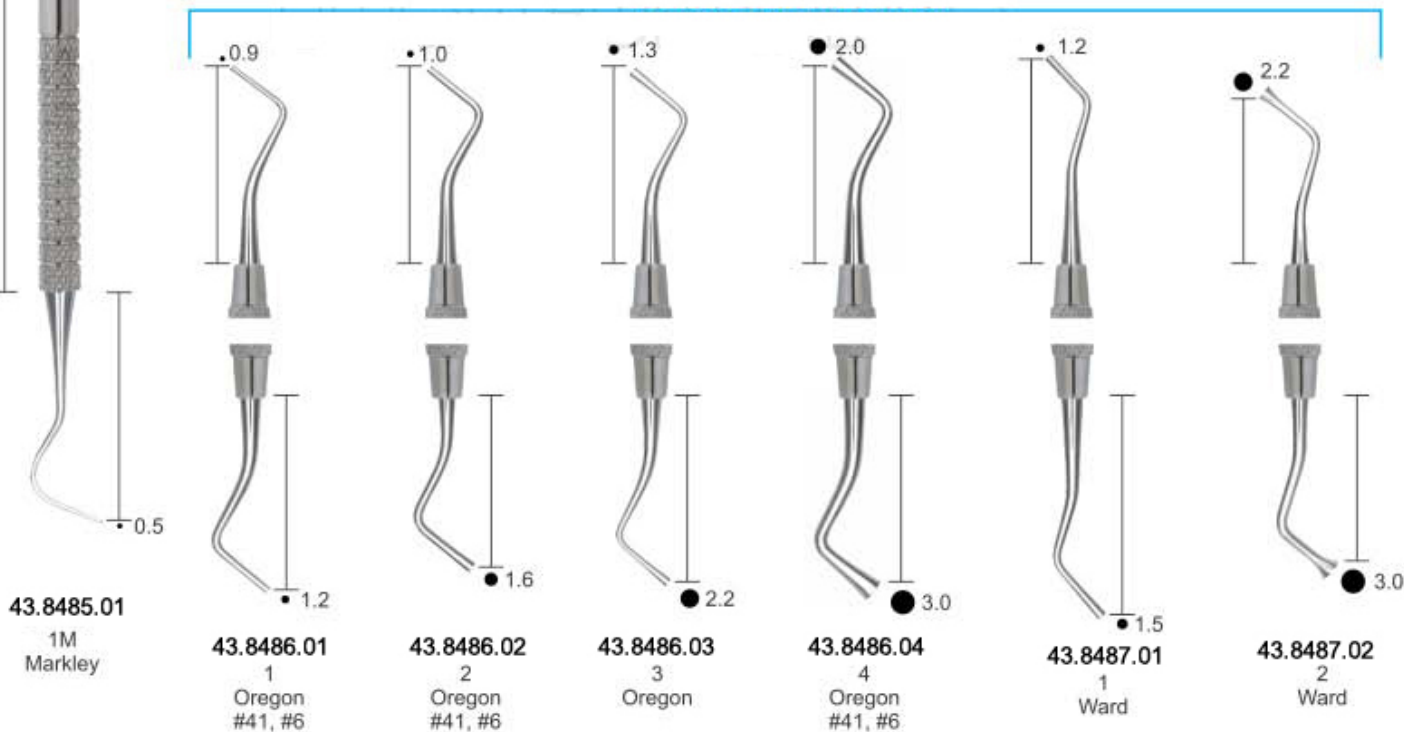

43.8485.01  
1M  
Markley

43.8486.01  
1  
Oregon  
#41, #6

43.8486.02  
2  
Oregon  
#41, #6

43.8486.03  
3  
Oregon

43.8486.04  
4  
Oregon  
#41, #6

43.8487.01  
1  
Ward

43.8487.02  
2  
Ward

- Инструменты для реставрации
- Instruments pour plombage
- Füllungsinstrumente (mit Kontrawinkel)
- Инструменти для реставрації
- Instrumentos para obturaciones
- ملء الصکورک

**RESTORATIVE INSTRUMENTS SOLID HANDLE 6MM. LENGTH 170MM**

**Tanner Filling Instruments**

**Back Action Filling Instruments**

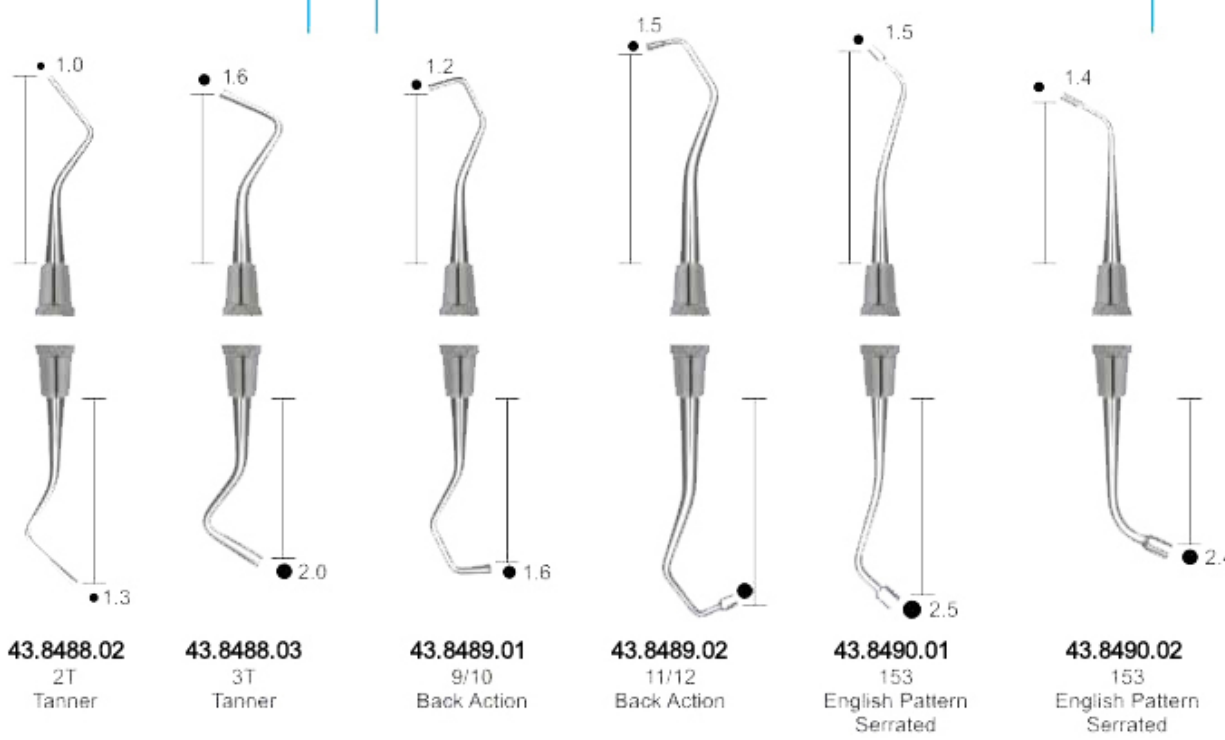
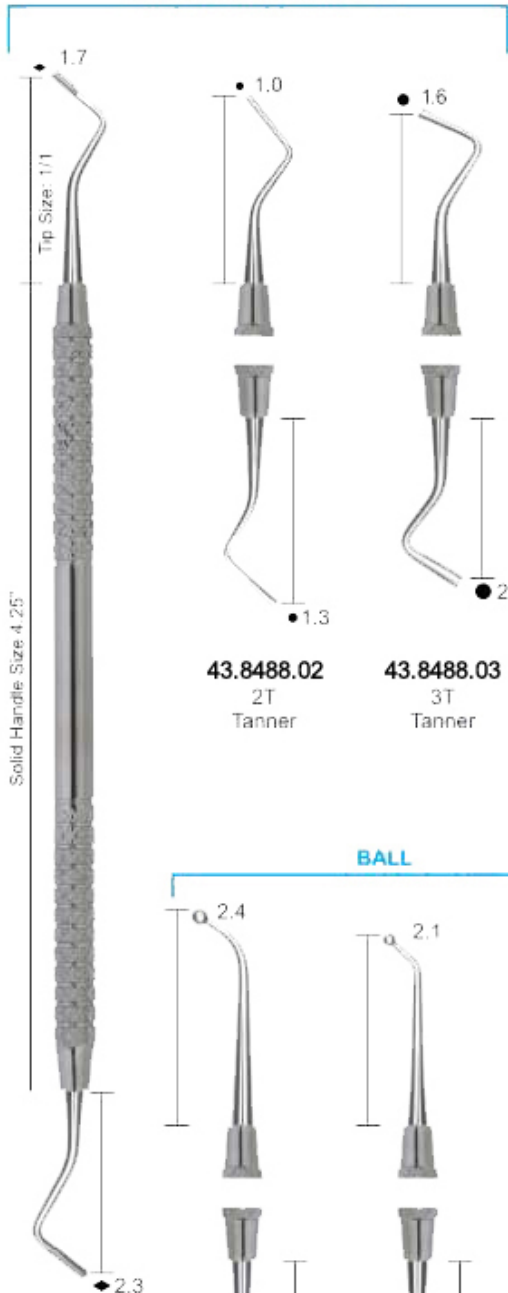

**BURNISHERS**

**BALL**

**BEAVERTAIL**

**ACORN**

**LADMORE**

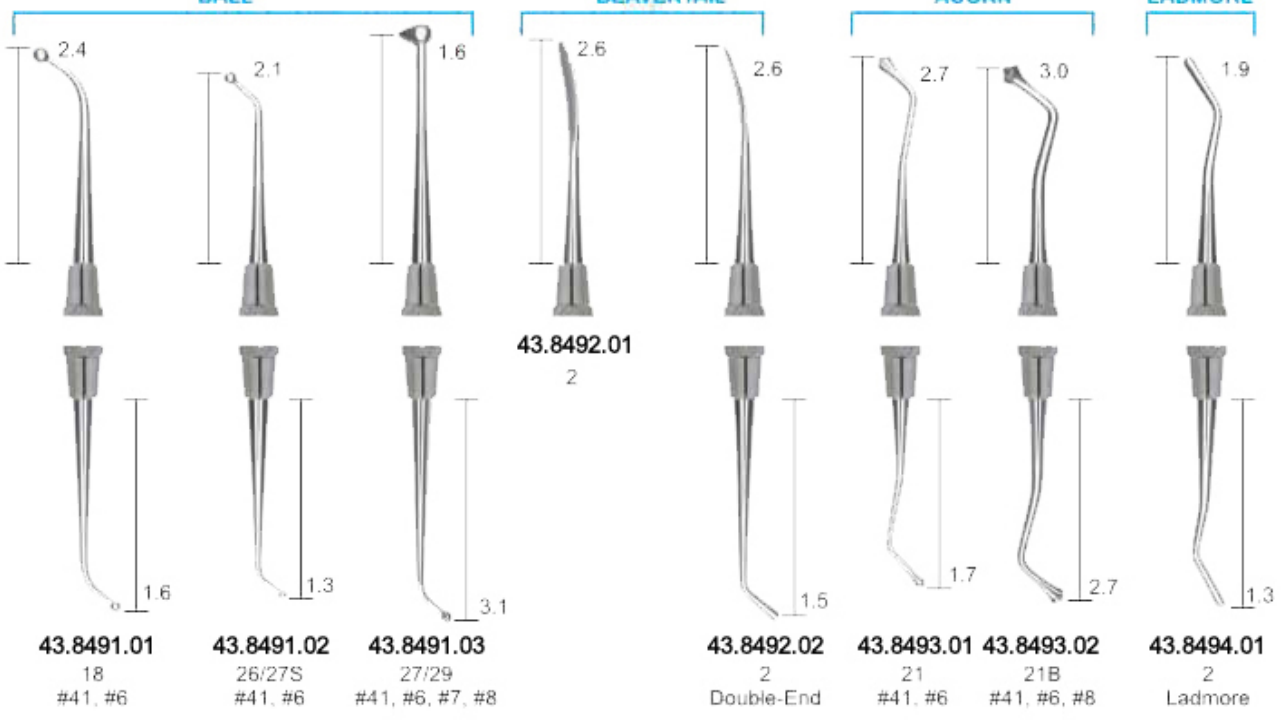

- Инструменты для реставрации
- Инструменти для реставрації
- Instruments pour plombage
- Instrumentos para obturaciones
- Füllungsinstrumente (mit Kontrawinkel)
- ملء الصنوك

RESTORATIVE INSTRUMENTS SOLID HANDLE 6MM, LENGTH 170MM

BURNISHERS

PERIODONTAL FILES

Tip Size 1/1

Solid Handle Size 4.25"

2.6

1.9

1.3

3.1

**43.8495.01**  
2/29

**43.8495.02**  
PKT-3R  
Rounded  
Cone  
#41, #6

**43.8495.03**  
Romerowski

**43.8495.04**  
3  
Ladmore  
#41, #6

Tip Size 1/1

Solid Handle Size 4.25"

**43.8496.01**  
9/10  
Schluger  
Curved File

**43.8496.02**  
11/12  
Buck  
Straight File

**43.8496.03**  
1S/2S  
Sugarman File  
Mesial/Distal

**43.8496.04**  
3S/4S  
Sugarman File  
Buccal/Lingual

- Инструменты для реставрации
- Instruments pour plombage
- Füllungsinstrumente (mit Kontrawinkel)

- Инструменты для реставрации
- Instrumentos para obturaciones
- ملء الصكوك

**COMPOSITE/PLASTIC FILLING INSTRUMENTS  
SOLID HANDLE 6MM, LENGTH 170MM**

**BURNISHER FILLING INSTRUMENTS**

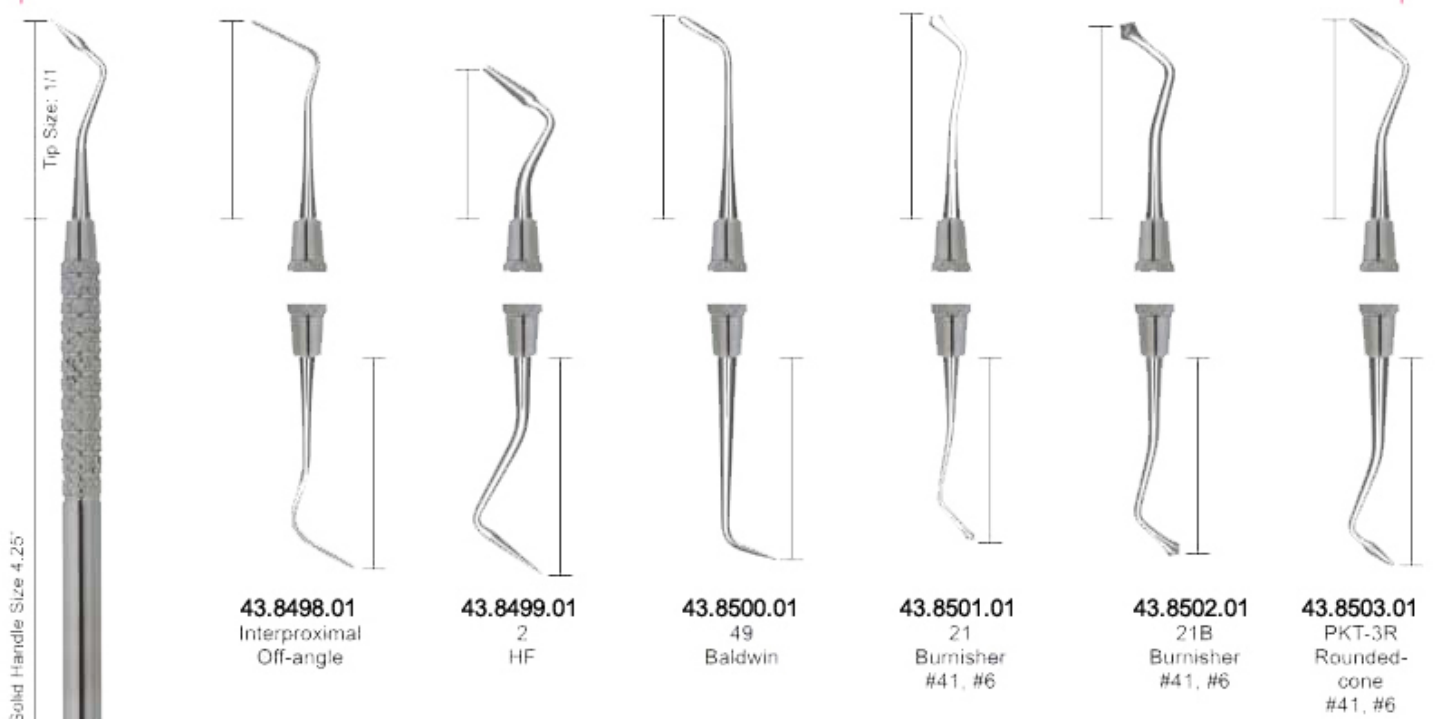

**UNIVERSAL FILLING INSTRUMENTS**

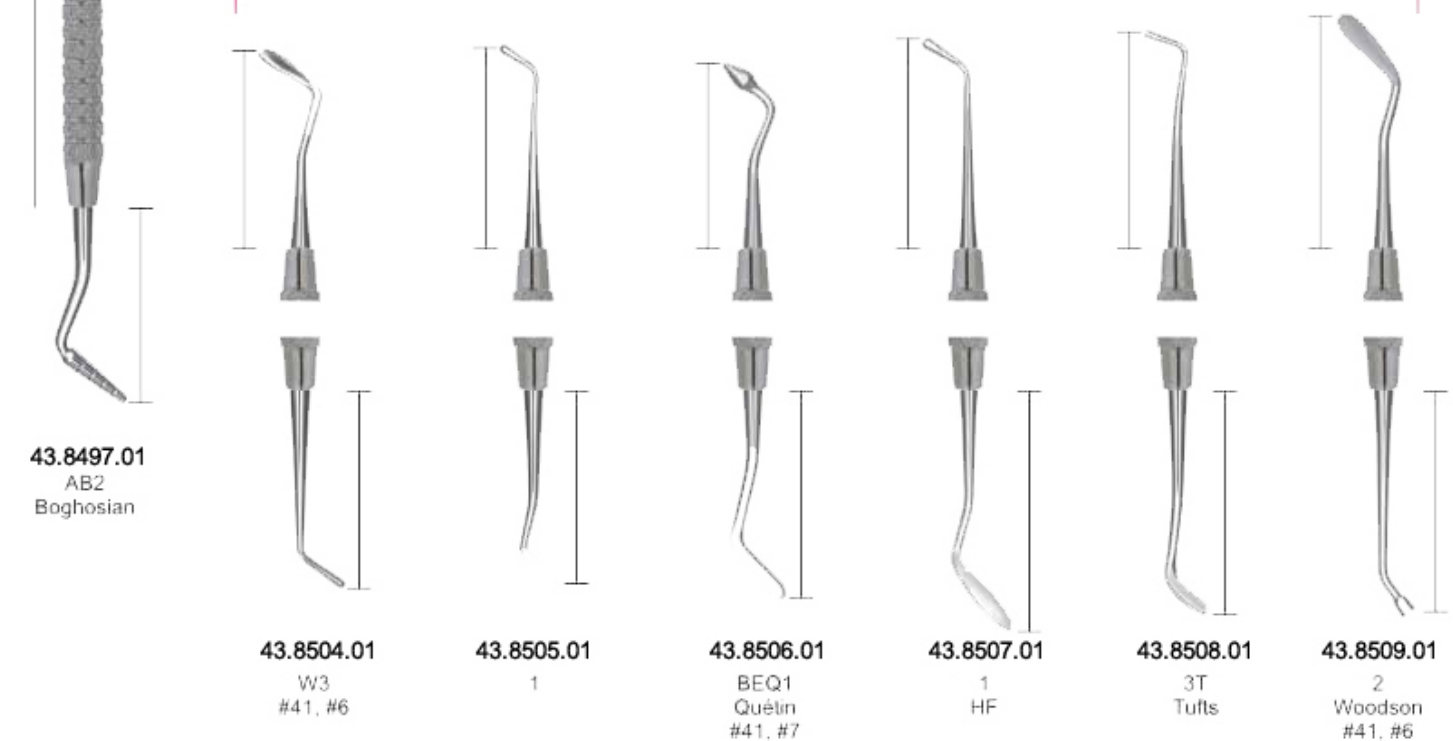

- Инструменты для реставрации
  - Instruments pour plombage
  - Füllungsinstrumente (mit Kontrawinkel)
- Инструменти для реставрації
  - Instrumentos para obturaciones
  - ملء الصكوك

**FILLING INSTRUMENTS  
SOLID HANDLE 6MM, LENGTH 170MM**



- Инструменты для реставрации
  - Instruments pour amalgame
  - Amalgampistolen
- Инструменти для реставрації
  - Instrumentos para amalgame
  - تقطیع المنعم

**AMALGAM INSTRUMENTS SOLID HANDLE 6MM, LENGTH 170MM**



- Инструменты для реставрации
- Instruments pour amalgame
- Amalgampistolen

- Инструменти для реставрації
- Instrumentos para amalgama
- قطيع المنعم

AMALGAM INSTRUMENTS  
SOLID HANDLE 6MM, LENGTH 170MM

Excavators Instruments Set of 11 Pieces

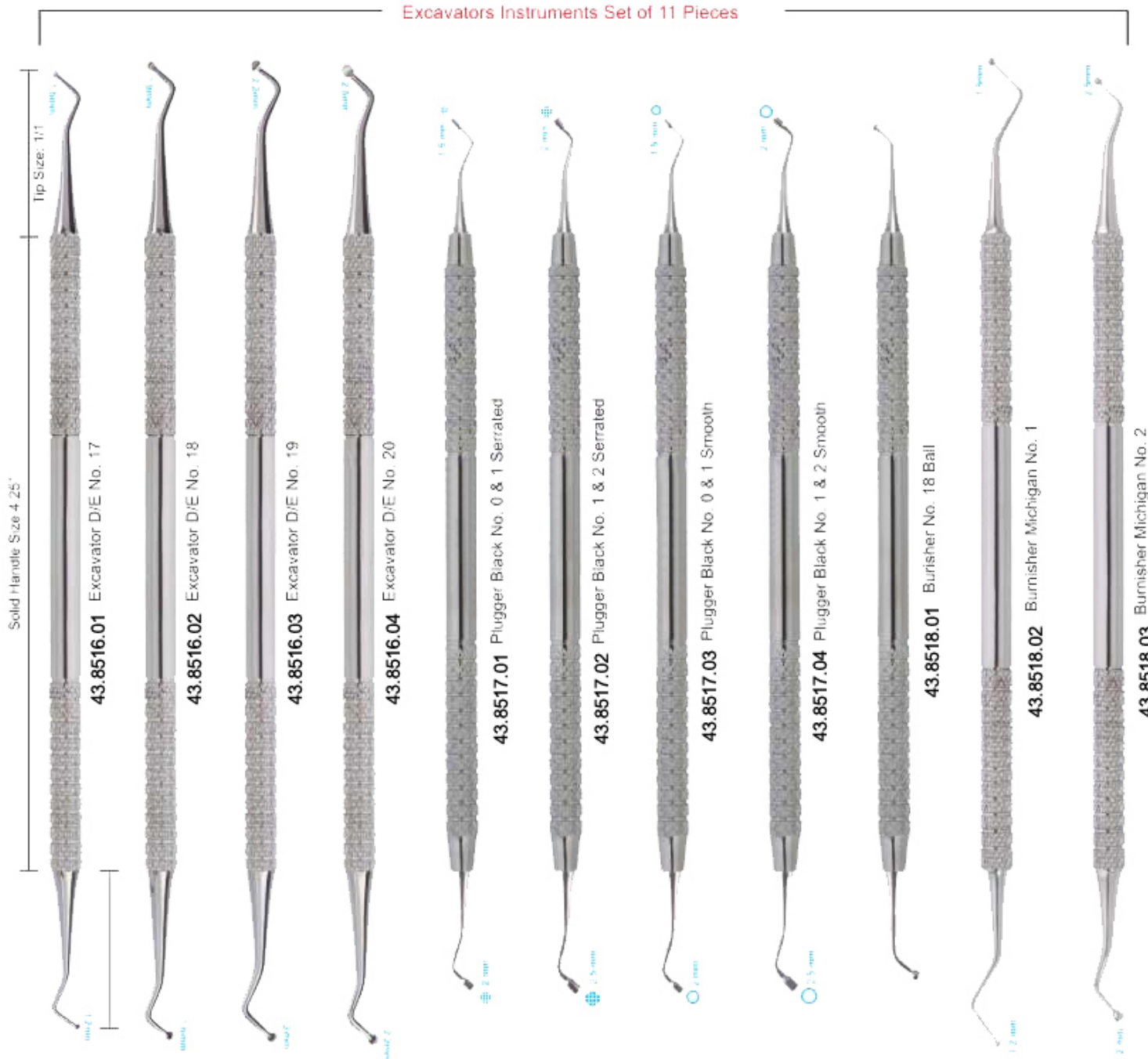

- Инструменты пародонтологические
- Instruments pour la parodontologie
- Instrumente für die Parodontologie
- Інструменти пародонтологічні
- Instrumentos para periodoncia
- الصكوك اللثة

**SICKLE SCALERS INSTRUMENTS SOLID HANDLE 6MM, LENGTH 170MM**

**SICKLE SCALERS**



**43.8519.01**  
H6/H7†  
Hygienist  
#2, #4, #6,  
#7, #8, #9

**43.8520.01**  
6/7  
Goldman  
#2, #4, #6,  
#7, #8

**43.8521.01**  
U15  
Towner  
#24, #6,  
#7, #8

**43.8522.01**  
H5/U15  
Hygienist-  
Towner  
#2, #4, #6

**43.8523.01**  
U15/30  
Towner-  
Jacquette  
#2, #4, #6  
#7, #8, #9

**43.8524.01**  
H15/33†  
Hygienist-  
Jacquette  
#2, #4, #6  
#7, #8, #9

**43.8525.01**  
U15/33  
Towner-  
Jacquette  
#2, #4, #6  
#7, #8, #9



- Инструменты пародонтологические
- Instruments pour la parodontologie
- Instrumente für die Parodontologie

- Інструменти пародонтологічні
- instrumentos para periodoncia
- الصكوك اللثة

PERIODONTAL INSTRUMENTS SOLID HANDLE 6MM, LENGTH 170MM

JACQUETTE SCALERS

CRANE-KAPLAN



- Инструменты пародонтологические
  - Instruments pour la parodontologie
  - Instrumente für die Parodontologie
- Інструменти пародонтологічні
  - Instrumentos para periodoncia
  - الصكوك اللثة

**PERIODONTAL INSTRUMENTS SOLID HANDLE 6MM, LENGTH 170MM  
SCALER/CURETTE SETS**

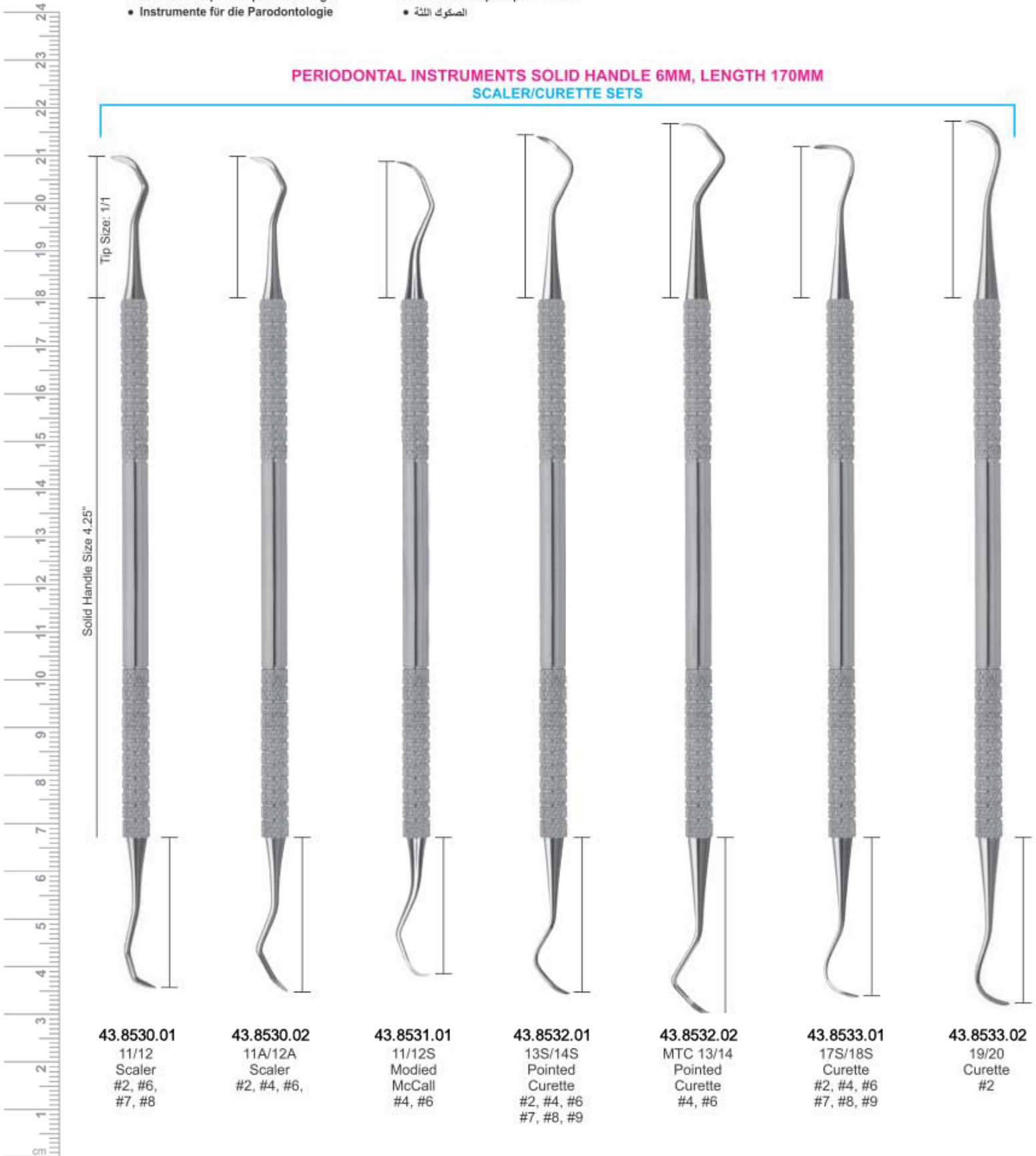

**43.8530.01**  
11/12  
Scaler  
#2, #6,  
#7, #8

**43.8530.02**  
11A/12A  
Scaler  
#2, #4, #6,

**43.8531.01**  
11/12S  
Modied  
McCall  
#4, #6

**43.8532.01**  
13S/14S  
Pointed  
Curette  
#2, #4, #6  
#7, #8, #9

**43.8532.02**  
MTC 13/14  
Pointed  
Curette  
#4, #6

**43.8533.01**  
17S/18S  
Curette  
#2, #4, #6  
#7, #8, #9

**43.8533.02**  
19/20  
Curette  
#2

- Кюрети
  - Curetas
  - Küretten
- Кюрети
  - Curette
  - كرتس

SCALER/CURETTE SETS

GOLDMAN-FOX SET

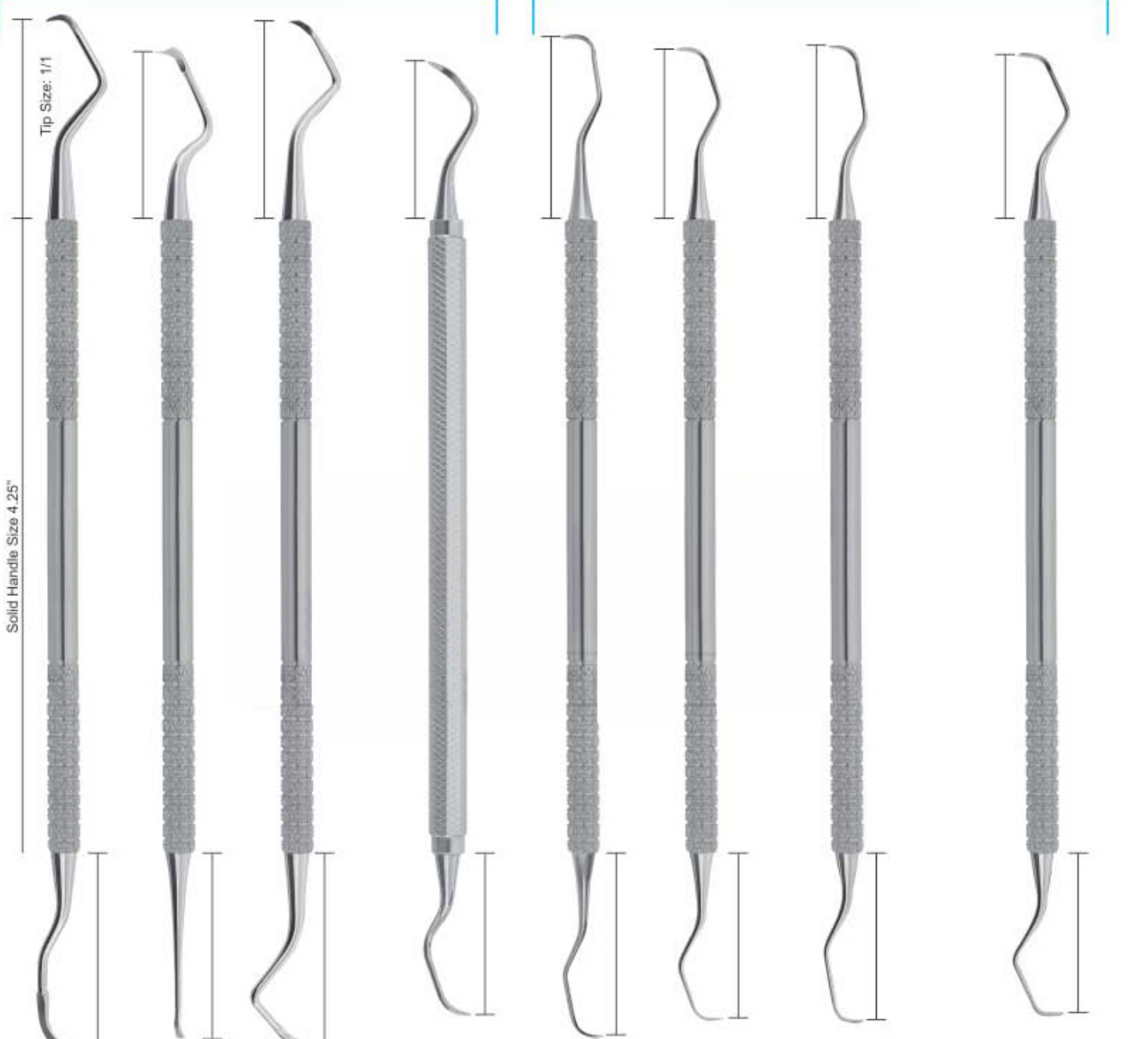

43.8534.01 103/106 #4, #6  
 43.8535.01 104/105 Hoe/Chisel #4, #6  
 43.8536.01 107/108 #2, #4, #6 #7, #8  
 43.8537.01 107/108S Modied #2, #4

43.8538.01 1/2 (shown) #2, #4, #6 #7, #8, #9  
 43.8538.02 1/2 Rigid #2, #4, #6 #7, #8, #9  
 43.8539.01 3/4† (shown) #2, #4, #6 #7, #8, #9  
 43.8539.02 3/4 Rigid #2, #4, #6 #7, #8, #9  
 43.8540.01 5/6† (shown) #2, #4, #6 #7, #8, #9  
 43.8540.02 5/6 Rigid #2, #4, #6 #7, #8, #9  
 43.8540.03 5/6 Extra Rigid #4, #6 #7, #8  
 43.8541.01 7/8† (shown) #2, #4, #6 #7, #8, #9  
 43.8541.02 7/8 Rigid #2, #4, #6 #7, #8, #9  
 43.8541.03 7/8 Extra Rigid #2, #4, #6 #7, #8, #9

SCALER/CURETTE SETS INSTRUMENTS  
 SOLID HANDLE 6MM, LENGTH 170MM

- Кюрети
- Curetas
- Kuretten
- Кюрети
- Curette
- كرتس

**GRACEY CURETTE INSTRUMENTS SOLID HANDLE 6MM, LENGTH 170MM**  
**GRACEY CURETTES**

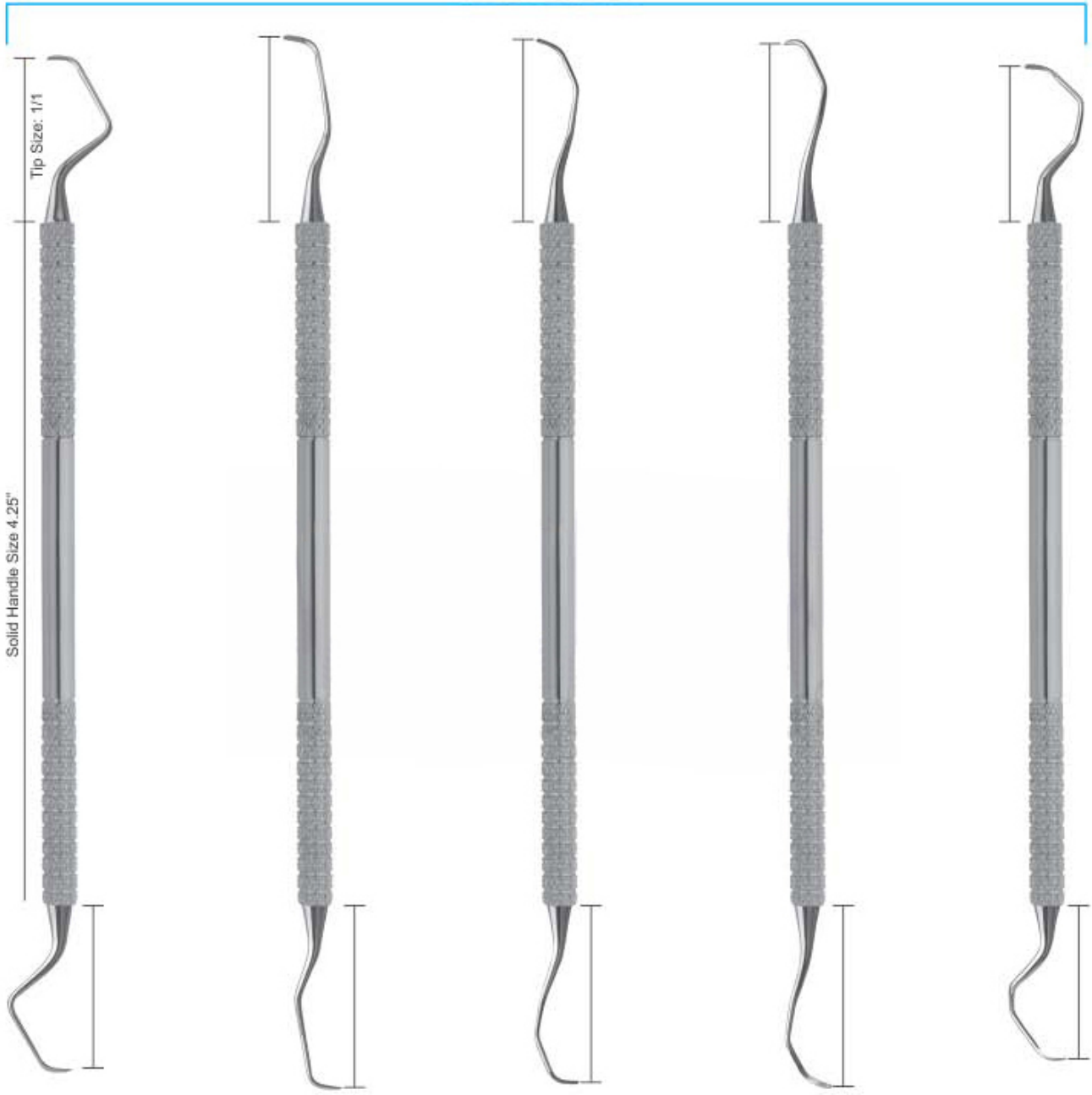

- |  |  |  |   |  |
|--|--|--|---|--|
| <p><b>43.8542.01</b><br/>9/10†<br/>(shown)<br/>#2, #4, #6<br/>#7, #8, #9</p> | <p><b>43.8543.01</b><br/>11/12†<br/>(shown)<br/>#2, #4, #6<br/>#7, #8, #9</p>  | <p><b>43.8544.01</b><br/>13/14†<br/>(shown)<br/>#2, #4, #6<br/>#7, #8, #9</p>  | <p><b>43.8545.01</b><br/>15/16†<br/>(shown)<br/>#2, #4, #6<br/>#7, #8, #9</p> | <p><b>43.8546.01</b><br/>17/18<br/>#2, #4, #6<br/>#7, #8, #9</p>           |
| <p><b>43.8542.02</b><br/>9/10<br/>Rigid<br/>#2, #4, #6<br/>#7, #8</p>        | <p><b>43.8543.02</b>   <b>43.8543.03</b><br/>11/12   11/12<br/>Rigid   Extra Rigid<br/>#2, #4, #6   #4, #6 #7,<br/>#7, #8, #9   #8</p> | <p><b>43.8544.02</b>   <b>43.8544.03</b><br/>13/14   13/14<br/>Rigid   Extra Rigid<br/>#2, #4, #6 #4, #6 #7,<br/>#7, #8, #9   #8</p> | <p><b>43.8545.02</b><br/>15/16<br/>Rigid<br/>#2, #4, #6<br/>#7, #8, #9</p>    | <p><b>43.8546.02</b><br/>17/18<br/>Rigid<br/>#2, #4, #6<br/>#7, #8, #9</p> |

- Кюрети
- Curetas
- Küretten

- Кюрети
- Curette
- كرتس

**CURETTE INSTRUMENTS  
HOLLOW HANDLE 8.5MM, LENGTH 170MM**

43.8547.02  
Hemingway  
2mm, 2mm

43.8547.03  
Hemingway  
3mm, 3mm

43.8547.04  
Hemingway  
4mm, 4mm

**CURETTE INSTRUMENTS  
SOLID HANDLE 6MM, LENGTH 170MM**

43.8548.02  
Hemingway  
2mm, 2mm

43.8548.03  
Hemingway  
3mm, 3mm

43.8548.04  
Hemingway  
4mm, 4mm

**CURETTE INSTRUMENTS  
SOLID HANDLE 6MM, LENGTH 170MM**



43.8549.02  
Hemingway  
2mm, 2mm

43.8549.03  
Hemingway  
3mm, 3mm

43.8549.04  
Hemingway  
4mm, 4mm

- Экскаваторы
- Excavateurs
- Excavatoren
- Excavatori
- Excavadores
- حطرات

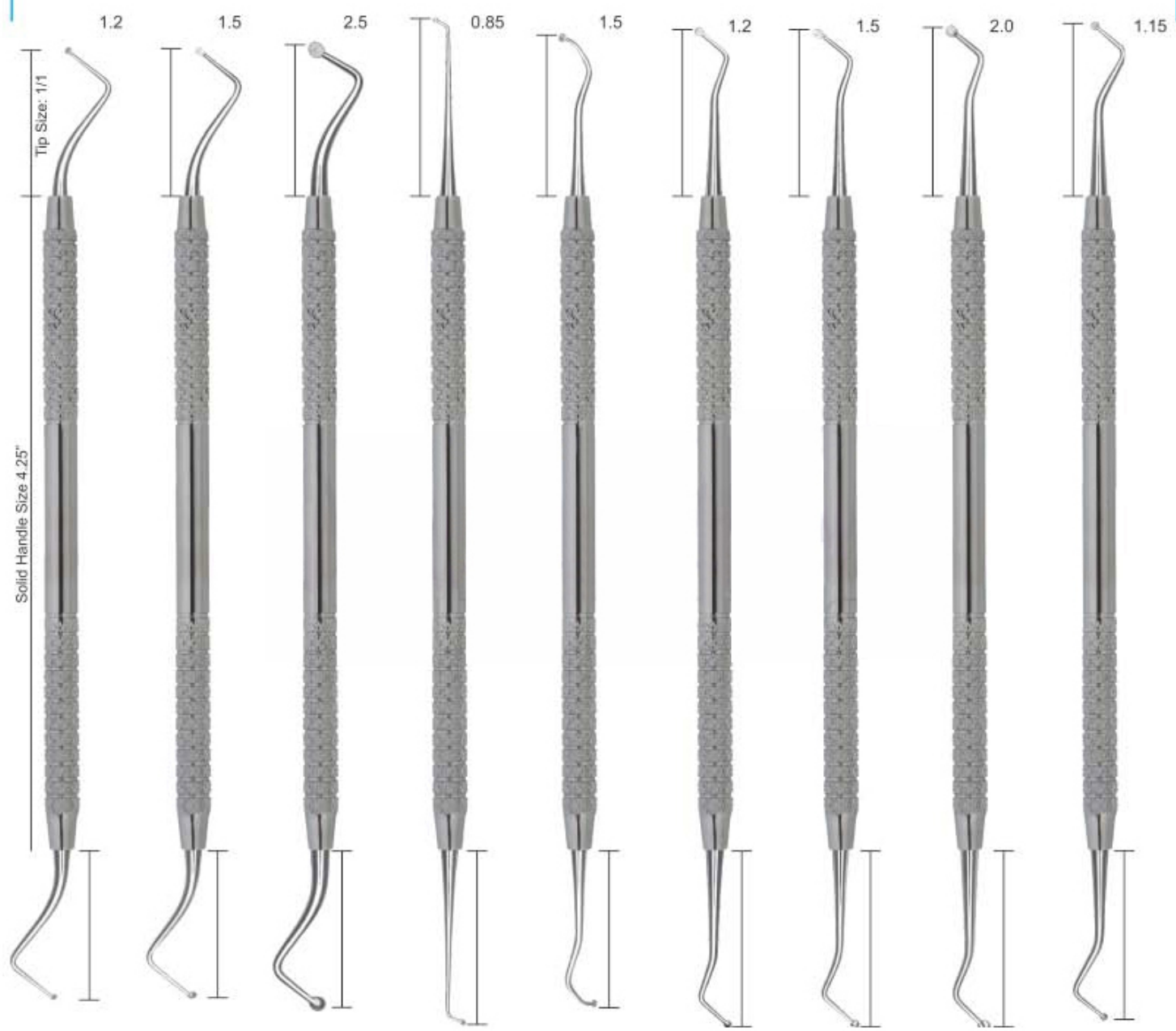
**EXCAVATORS INSTRUMENTS SOLID HANDLE 6MM, LENGTH 170MM** **SPOONS**



<b>43.8550.01</b>	<b>43.8550.02</b>	<b>43.8550.03</b>	<b>43.8551.01</b>	<b>43.8551.02</b>	<b>43.8552.17</b>	<b>43.8552.18</b>	<b>43.8552.19</b>	<b>43.8552.38</b>
E1	E2	E3	6	14	17	18	19	38/39
(12-9-15)	(15-9-15)	(25-9-15)			#41, #6, #7, #8	#41, #6, #7, #8	#41, #6, #7, #8	(11.5-7-14)
#41, #6	#41, #6							#41, #6, #7

- Экскаваторы
- Excavateurs
- Excavatoren
- Экскаватори
- Excavadores
- حفارات

EXCAVATORS INSTRUMENTS

OVAL SPOONS/DARBY-PERRY

SOLID HANDLE 6MM, LENGTH 170MM

EXCAVATORS

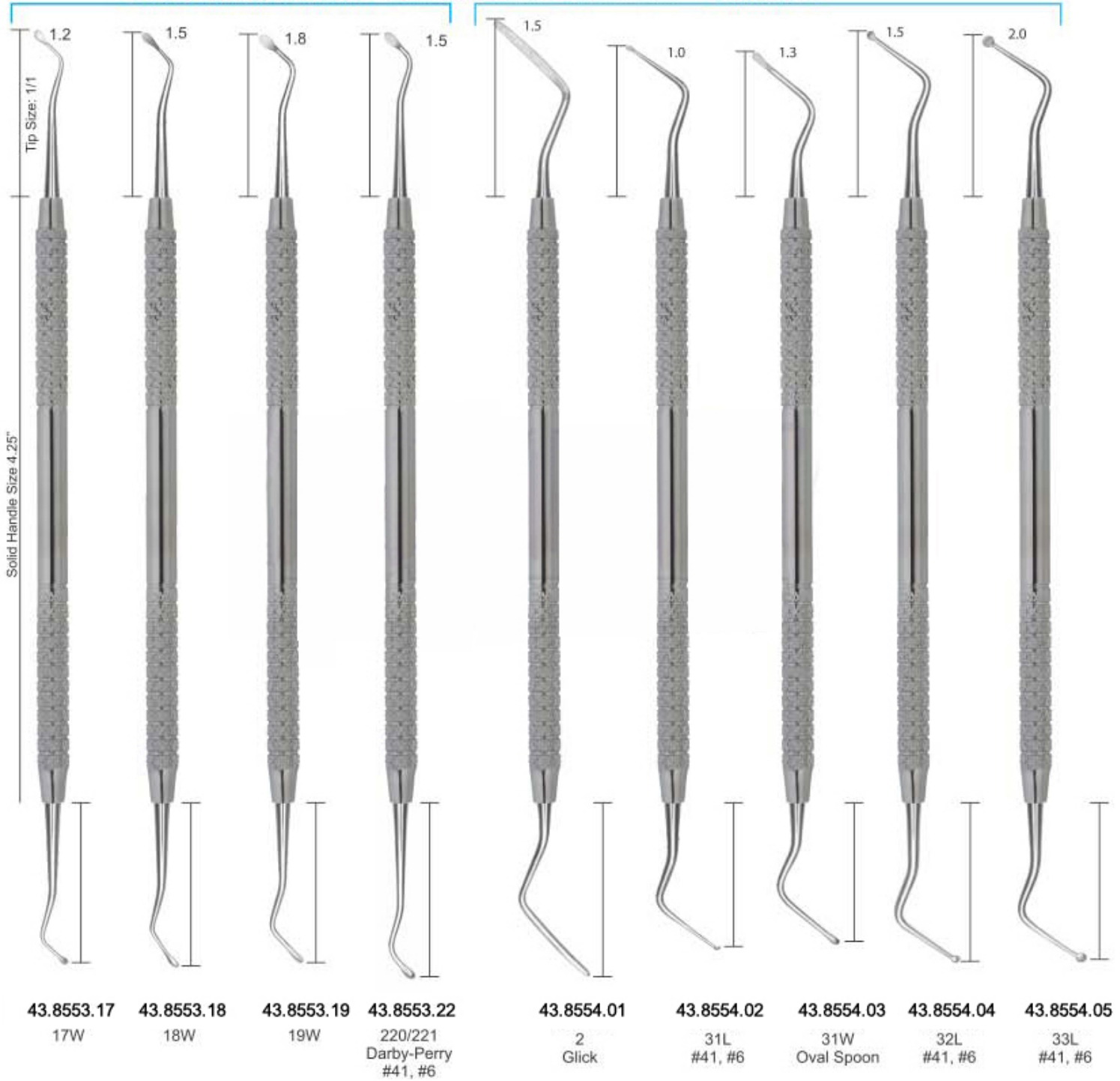

- Экскаваторы
- Excavateurs
- Excavatoren
- عسكافطوري
- Excavadores
- حفارات

EXCAVATORS INSTRUMENTS  
SOLID HANDLE 6MM, LENGTH 170MM

BLADES

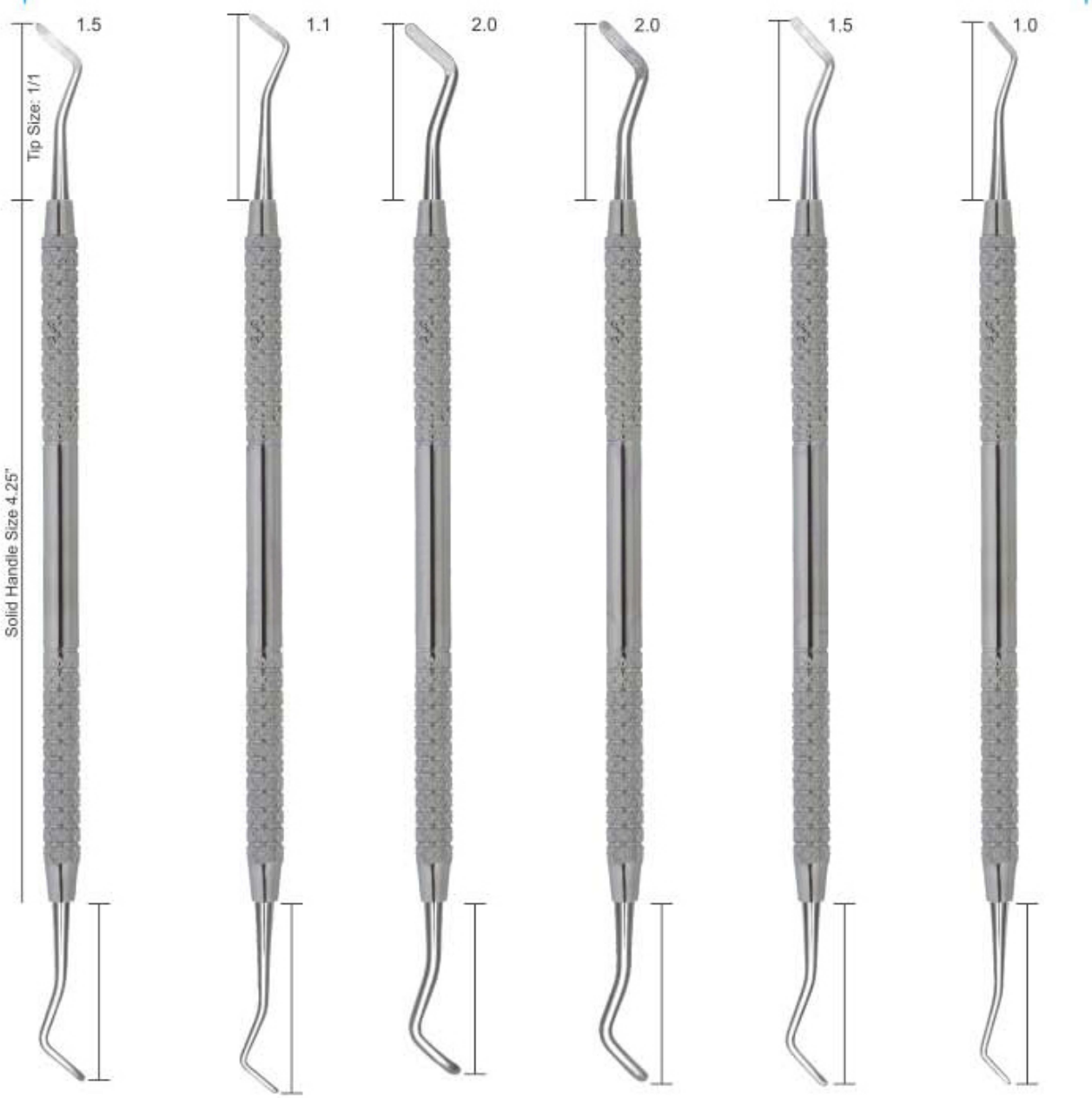

**43.8555.01**  
36/37  
(15-8-14)  
#41, #6

**43.8555.02**  
40/41  
(11-7-14)

**43.8555.03**  
44/45  
(20-9-14)  
#41, #6

**43.8555.04**  
61/62  
(20-9-12)

**43.8555.05**  
63/64  
(15-8-12)

**43.8555.06**  
65/66  
(10-6-12)



- Экскаваторы
- Excavateurs
- Excavatoren
- Экскаватори
- Excavadores
- حفارات

EXCAVATORS INSTRUMENTS SOLID HANDLE 6MM, LENGTH 170MM

ENGLISH PATTERNS



43.8556.01	43.8556.02	43.8556.03	43.8556.04	43.8556.05	43.8556.06	43.8556.07	43.8556.08	43.8556.09	43.8556.10
Goldstein	243	244	245	246	125/126	127/128	129/130	131/132	153/154
Interproximal					#41, #6	#41, #6	#41, #6	#41, #6	
Excavator									

- Инструменты для реставрации
- Instruments pour plombage
- Füllungsinstrumente (mit Kontrawinkel)
- Инструменти для реставрації
- Instrumentos para obturaciones
- ملء الصكوك

**HATCHETS**

**RESTORATIVE INSTRUMENTS SOLID HANDLE 6MM, LENGTH 170MM**

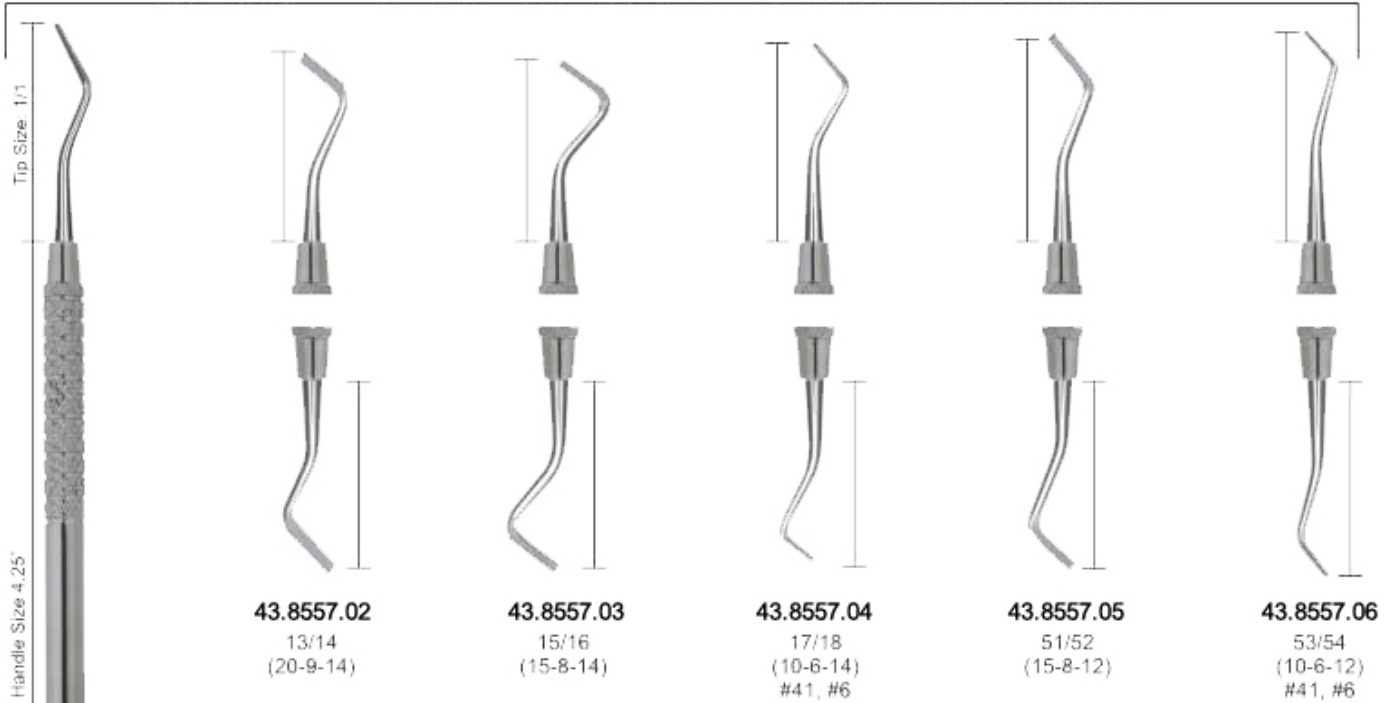

**ANTERIOR**

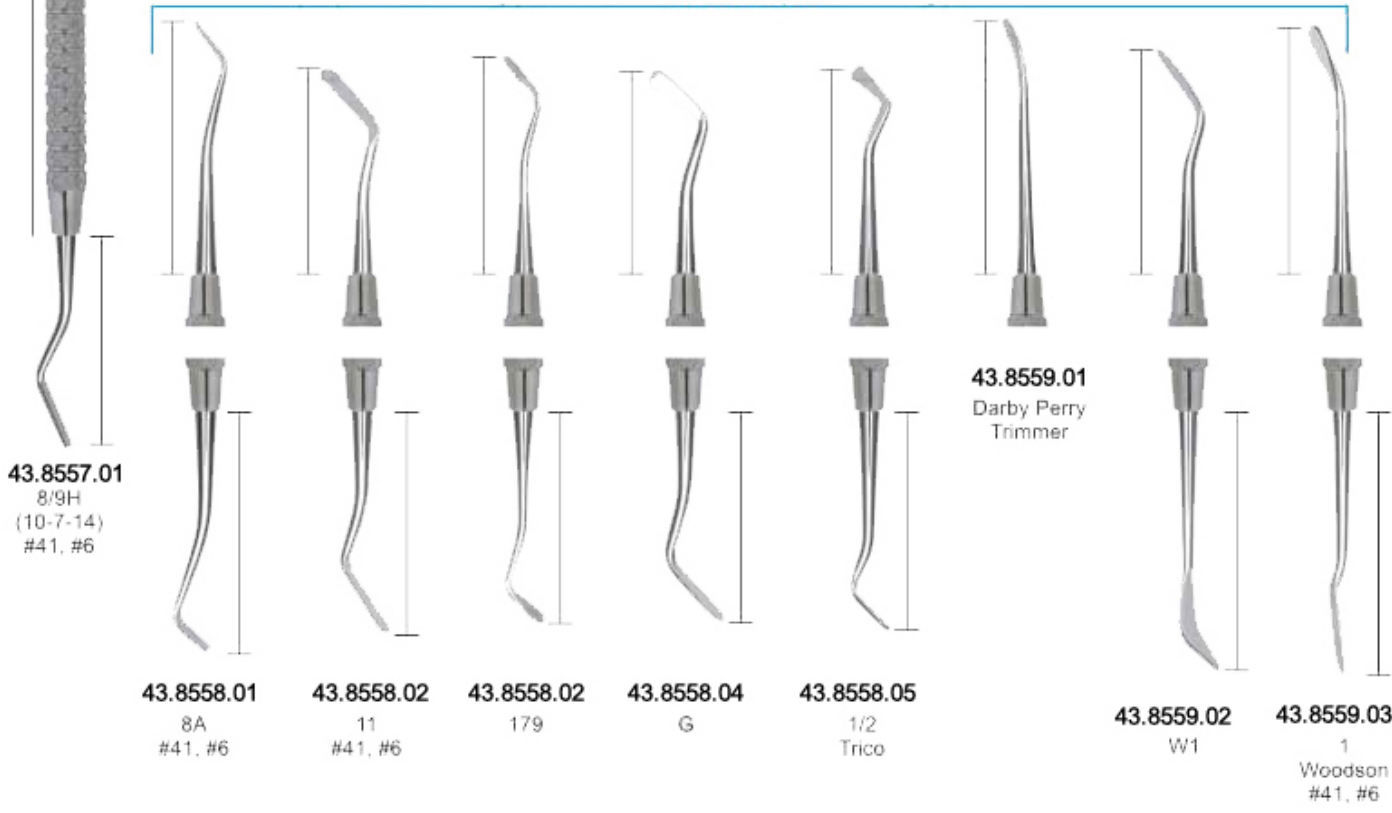

- Инструменты для реставрации
- Instruments pour plombage
- Füllungsinstrumente (mit Kontrawinkel)

- Инструменты для реставрации
- Instrumentos para obturaciones
- ملء نصوصه

**CARVERS**

**RESTORATIVE INSTRUMENTS SOLID HANDLE 6MM, LENGTH 170MM**



**43.8560.02**  
Inter-proximal  
Off-Angle



**43.8561.01**  
1/2-3  
Hollenback  
#41, #6,  
#7, #8



**43.8561.02**  
3S  
Hollenback  
#41, #6, #7



**43.8561.03**  
3  
Hollenback



**43.8562.01**  
8  
Wiland  
Minn IPC1  
#41, #6, #7

**43.8560.01**  
Inter-proximal  
#41, #6, #7

**TANNER**



**43.8563.01**  
3  
Tanner

**43.8563.02**  
4  
Tanner

**43.8563.03**  
5  
Tanner

**43.8563.04**  
6  
Tanner

**WALL**



**43.8564.01**  
1  
Wall

**43.8564.02**  
3  
Wall

**WARD**

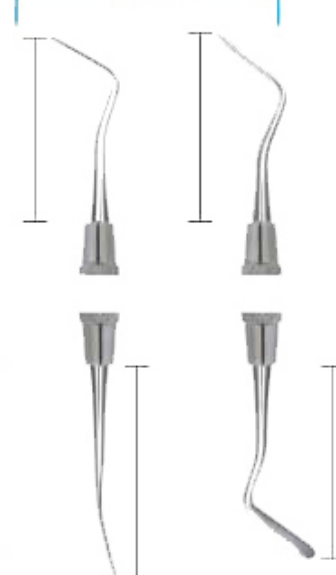

**43.8565.01**  
1  
Ward

**43.8565.02**  
2  
Ward

- Инструменты для реставрации
- Instruments pour amalgame
- Amalgampistolen
- Инструменты для реставрації
- instrumentos para amalgama
- تقطیع المنلفم

**RESTORATIVE INSTRUMENTS**

**ANDREW** SOLID HANDLE 6MM, LENGTH 170MM **CLAPPISON/FRAHAM**

**HOLLENBACK**

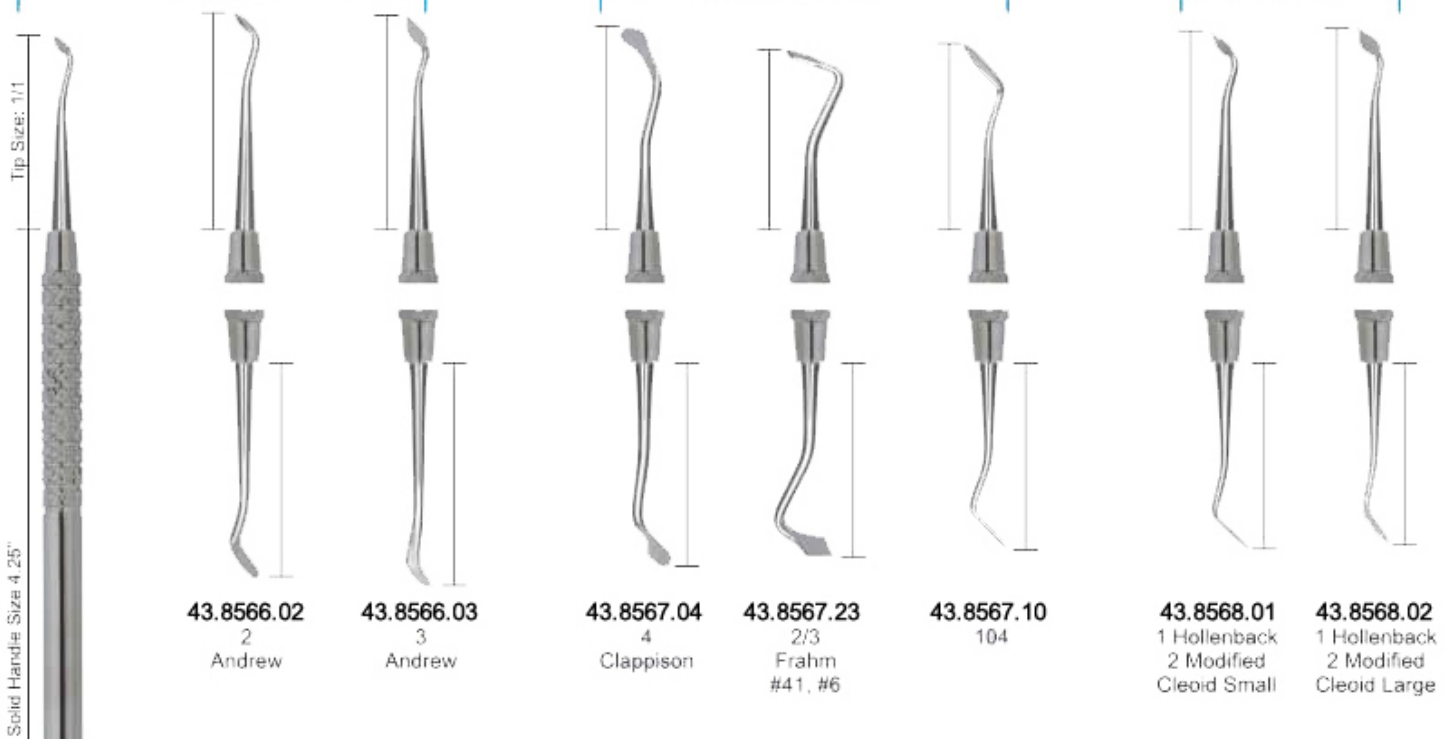

**43.8566.02**  
2  
Andrew

**43.8566.03**  
3  
Andrew

**43.8567.04**  
4  
Clappison

**43.8567.23**  
2/3  
Frahm  
#41, #6

**43.8567.10**  
104

**43.8568.01**  
1 Hollenback  
2 Modified  
Cleoid Small

**43.8568.02**  
1 Hollenback  
2 Modified  
Cleoid Large

**HOLLENBACK**

**THARP**

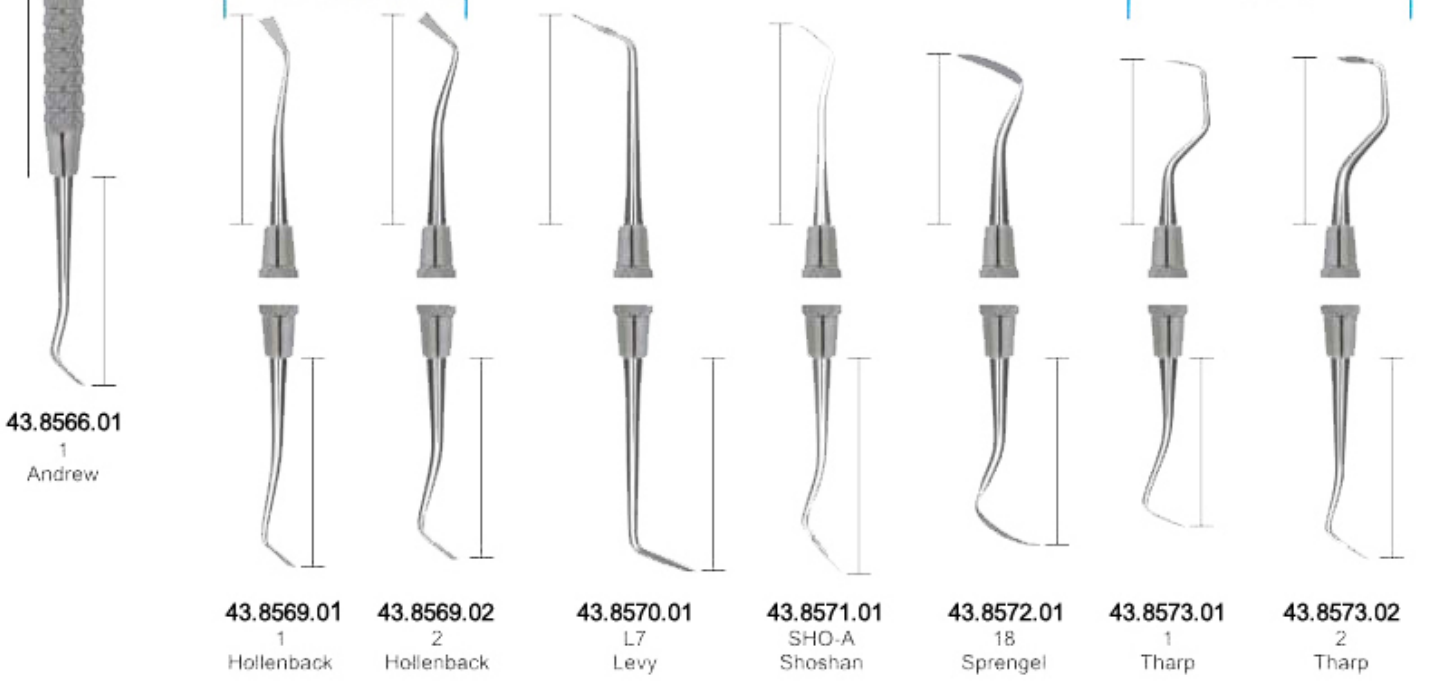

**43.8566.01**  
1  
Andrew

**43.8569.01**  
1  
Hollenback

**43.8569.02**  
2  
Hollenback

**43.8570.01**  
L7  
Levy

**43.8571.01**  
SHO-A  
Shoshan

**43.8572.01**  
18  
Sprengel

**43.8573.01**  
1  
Tharp

**43.8573.02**  
2  
Tharp

- Инструменты для реставрации
- Instruments pour amalgame
- Amalgampistolen
- Инструменты для реставрації
- instrumentos para amalgama
- تقطيع المنعم

RESTORATIVE INSTRUMENTS SOLID HANDLE 6MM, LENGTH 170MM

HOES

Forming Line Angles on Anterior Preparations.

CARVERS

AMALGAM FILES



43.8574.01  
Anatomical  
Carver

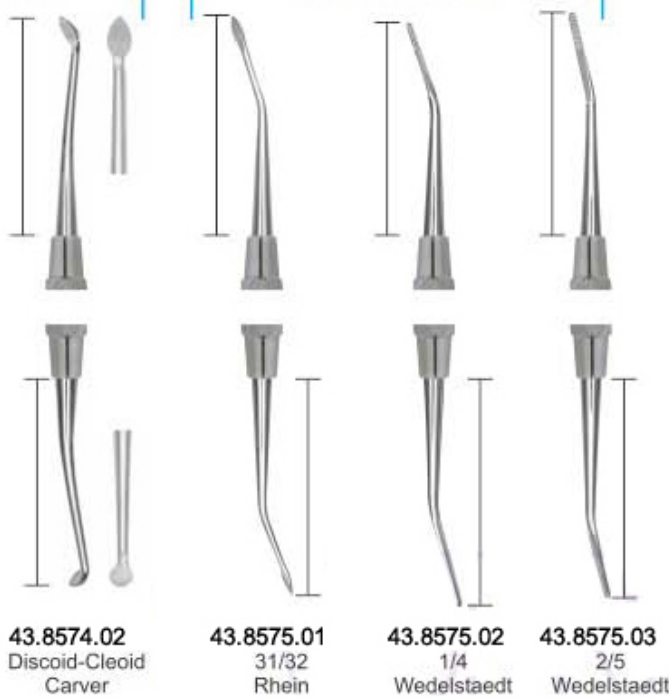

43.8574.02 Discoid-Cleoid Carver  
43.8575.01 31/32 Rhein  
43.8575.02 1/4 Wedelstaedt  
43.8575.03 2/5 Wedelstaedt

DISCOID-CLEOIDS

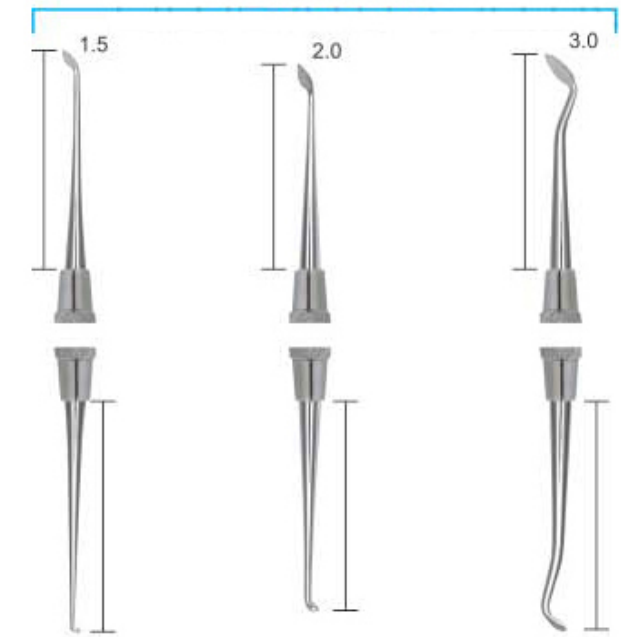

43.8576.01 1/2  
43.8576.02 4/5 #41, #6, #7  
43.8576.03 3/6 #41, #6, #7



43.8577.02 21 (10-4-8)  
43.8577.03 22 (10-4-14)  
43.8577.04 23 (6.5-2.5-9)



43.8577.01 20 (14-6-8)

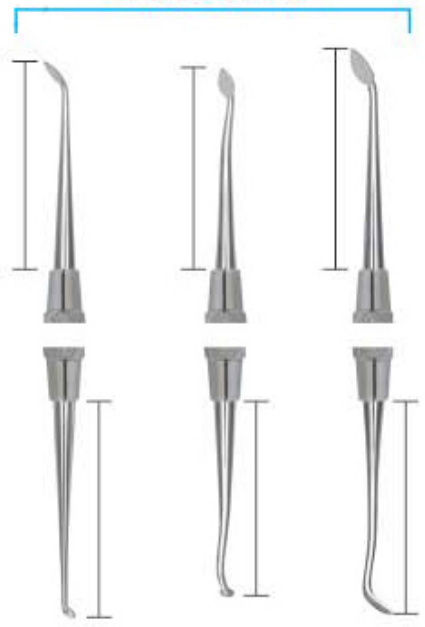

43.8578.01 89/92 #41, #6, #7  
43.8578.02 90B  
43.8578.03 W-A-C-D

- Инструменты для реставрации
- Instruments pour plombage
- Füllungsinstrumente (mit Kontrawinkel)

- Инструменти для реставрації
- Instrumentos para obturaciones
- ملء الصكوك

**RESTORATIVE INSTRUMENTS**  
**SOLID HANDLE 6MM, LENGTH 170MM**

**MARGIN TRIMMERS**

**ANGLE FORMERS**



**43.8579.01**  
26  
(13-95-8-14)  
Distal



**43.8579.02**  
27  
(13-80-8-14)  
Mesial



**43.8579.03**  
28  
(10-95-7-14)  
Distal  
#41, #6



**43.8579.04**  
29  
(10-80-7-14)  
Mesial  
#41, #6



**43.8579.05**  
77/78  
(15-95-8-12)  
Distal



**43.8579.06**  
79/80  
(15-80-8-12)  
Mesial



**43.8580.01**  
30/31  
(12-80-5-8)



**43.8580.02**  
32/33  
(9-80-4-8)



**43.8580.03**  
34/35  
(7-80-2.5-9)

- Инструменты для реставрации
- Instruments a modeler
- Modellierinstrumente

- Инструменти для реставрації
- Instrumentos para modelar
- أدوات تلميع

**P.K. THOMS WAXING INSTRUMENTS SOLID HANDLE 6MM, LENGTH 170MM**

**P.K. THOMAS WAXING INSTRUMENTS**

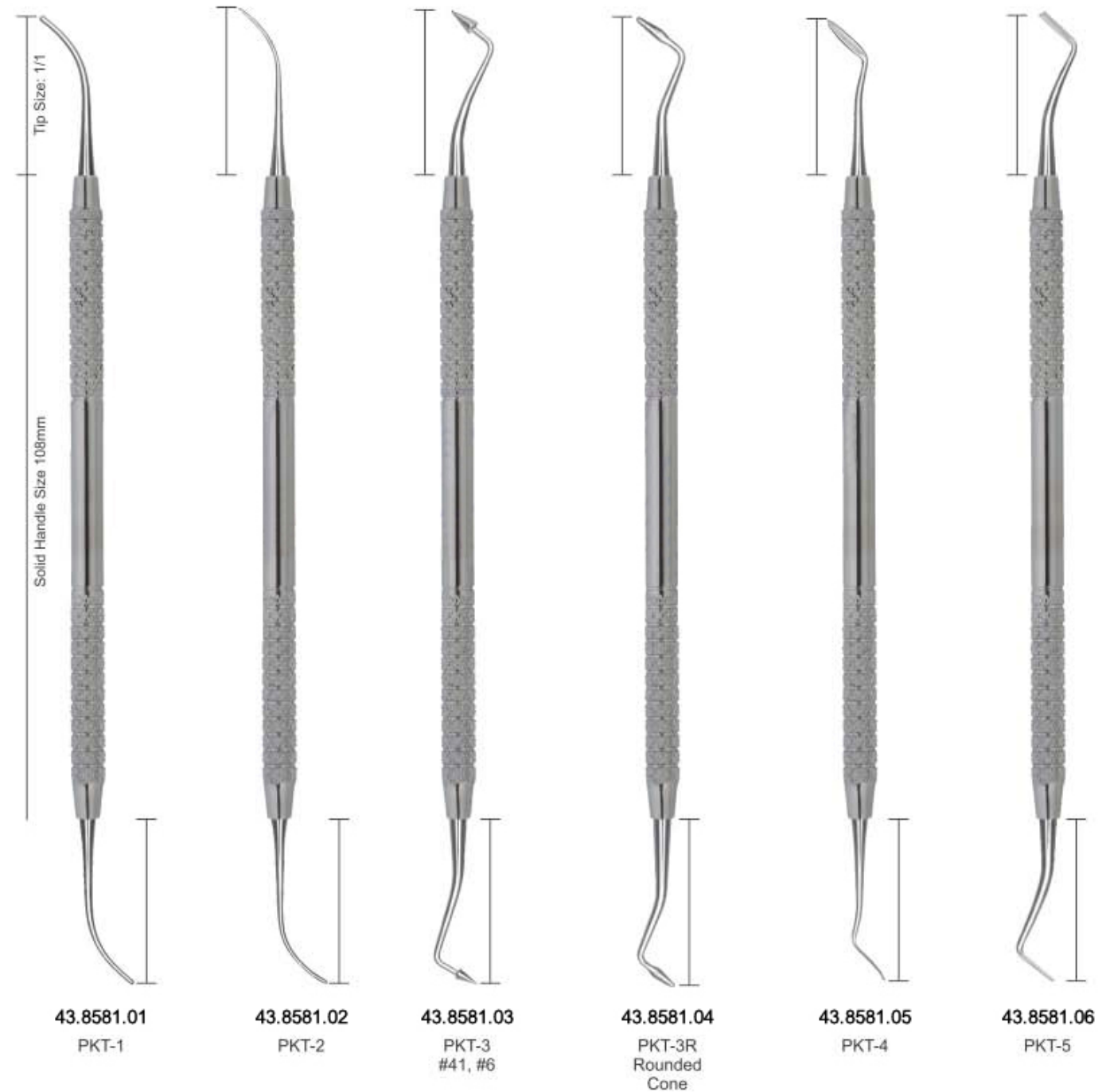

- Инструменты для реставрации
- Instruments pour plombage
- Füllungsinstrumente (mit Kontrawinkel)
- Инструменти для реставрації
- Instrumentos para obturaciones
- ملء الصكوك

**CHISELS**

**HOES**



Instrument ID	Tip Size	Handle Size	Instrument Type
43.8582.01	1/1	108mm	Chisel (Werdelstaedt)
43.8582.02	3/4	108mm	Chisel (Werdelstaedt)
43.8583.01	7	122mm	Chisel (Straight)
43.8583.02	5/6	108mm	Chisel (Straight)
43.8583.03	7/10	108mm	Chisel (Straight)
43.8584.01	8/9	108mm	Hoe (Binangle)
43.8584.02	11/12	108mm	Hoe (Binangle)
43.8584.03	40/41	108mm	Hoe (Binangle)



- Инструменты для реставрации
  - Instruments pour plombage
  - Füllungsinstrumente (mit Kontrawinkel)
- Инструменти для реставрації
  - Instrumentos para obturaciones
  - ملء الصكوك

## CHISELS

## HOES

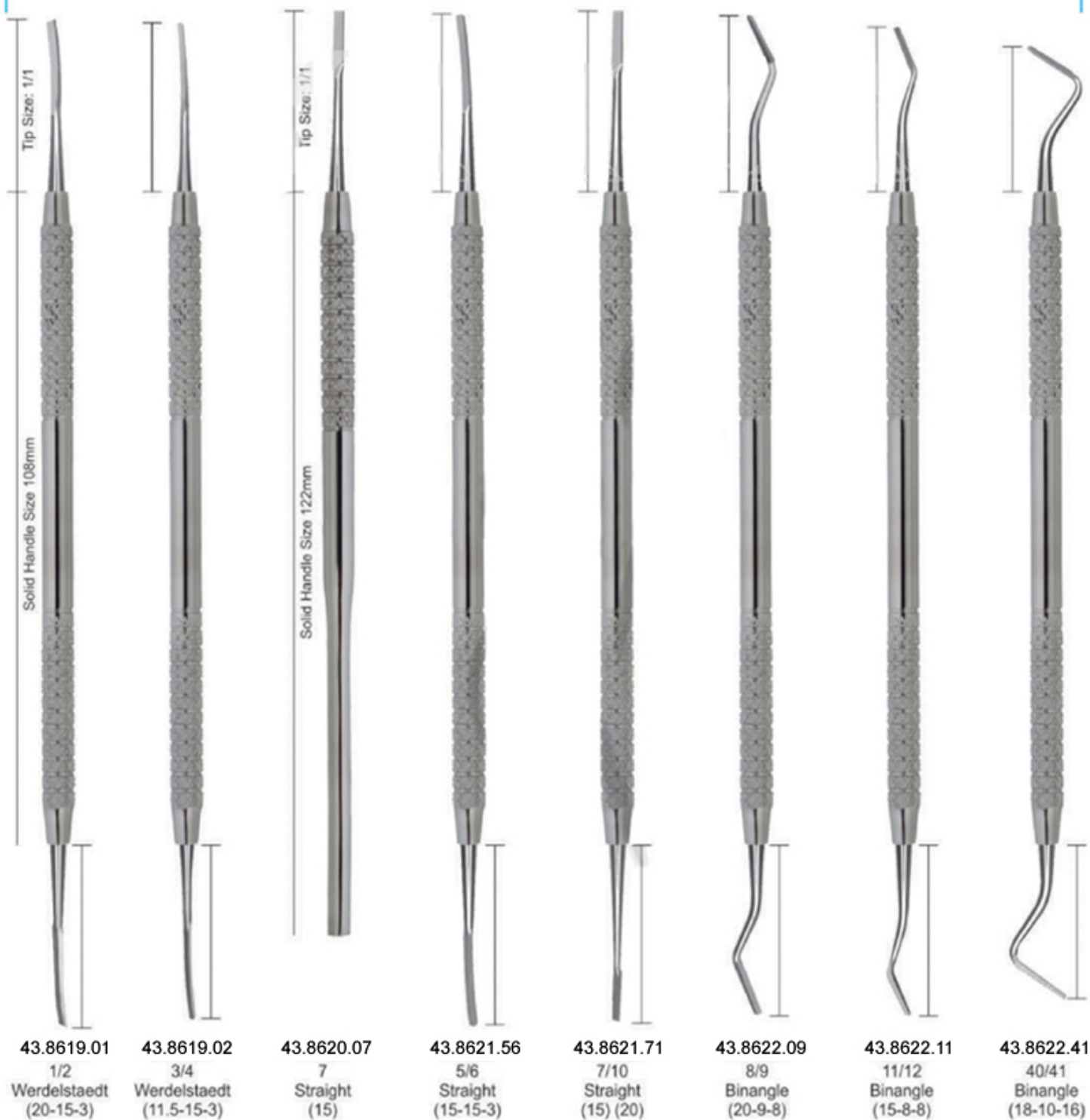

**Composite Gold Tip Instruments**

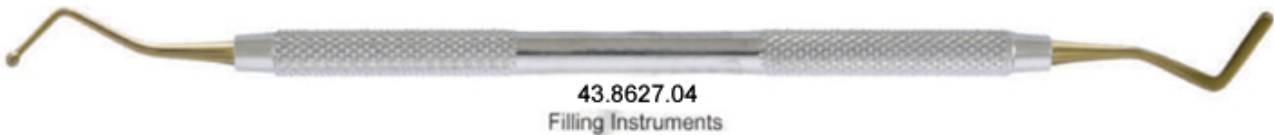
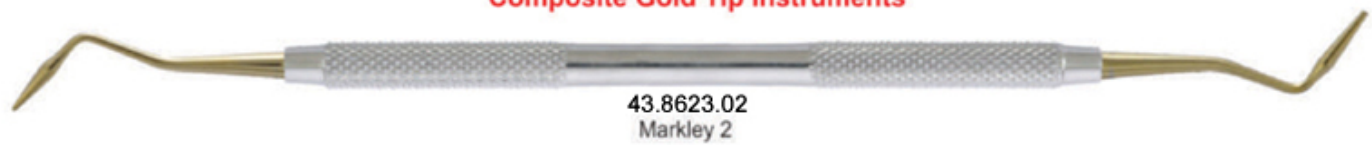

## COMPOSITE INSTRUMENTS TITANIUM BLUE ENDODONTIC

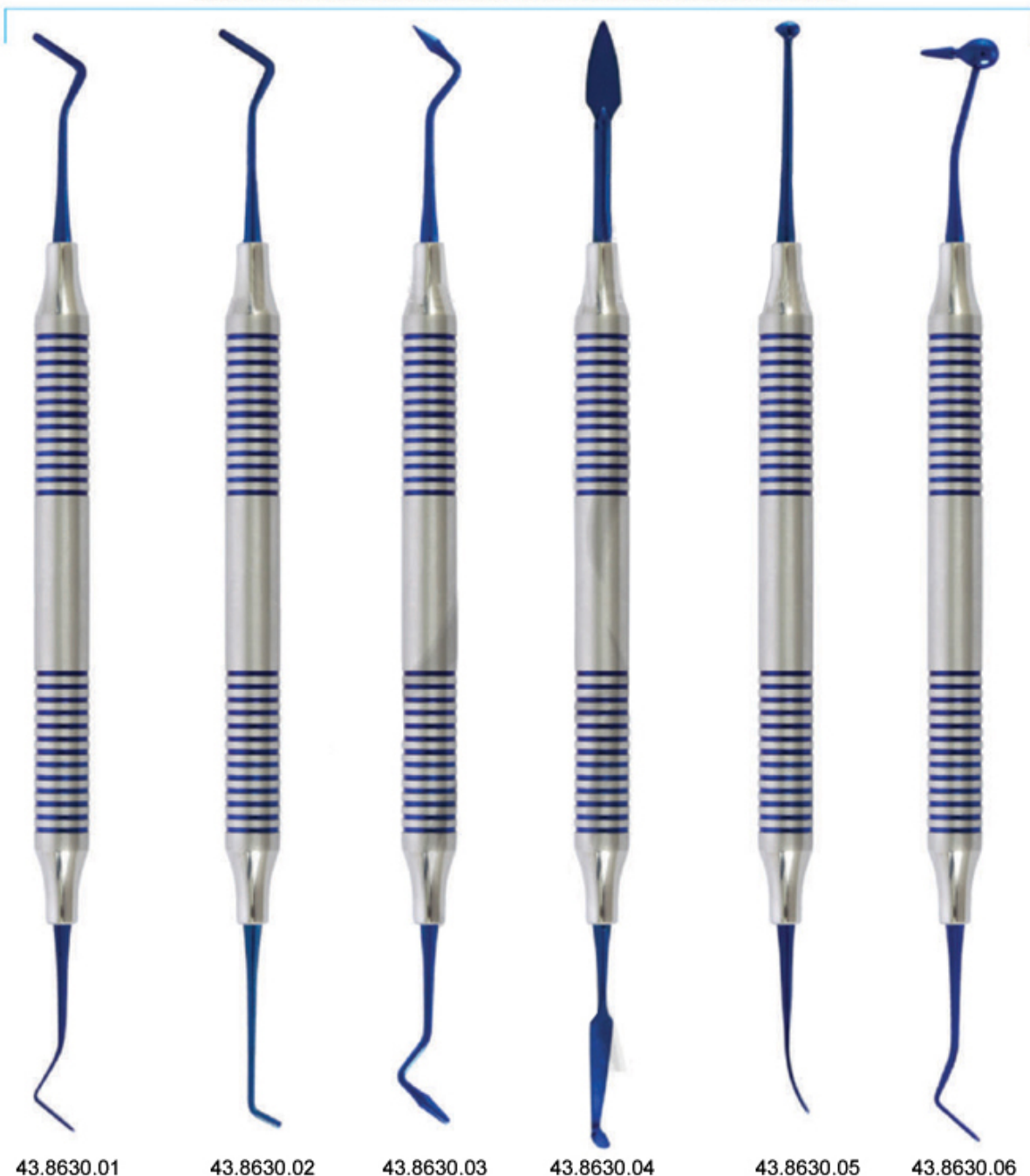

43.8630.01

43.8630.02

43.8630.03

43.8630.04

43.8630.05

43.8630.06



43.8630.07

 Composite Instruments Blue  
Titanium with Cassettes



43.8631.01

X Ray Film Hangers



43.8631.02

X Ray Film Hangers



43.8631.03

X Ray Film Hangers



43.8631.04

X Ray Film Hangers



43.8631.05

X Ray Film Hangers



43.8631.06

X Ray Film Hangers



43.8631.07

X Ray Film Hangers



43.8632.01



43.8632.02



43.8632.03



Dissecting Set  
43.8634.09 Set of 9 Pcs.  
43.8634.11 Set of 11 Pcs.



43.8633.01

Napkin Holder with Plastic Chain

43.8633.02

Napkin holder with metal chain



Mouth Props  
43.8635.01  
Small

Mouth Props  
43.8635.02  
Medium

Mouth Props  
43.8635.03  
Large

Key Rings



43.8636.01



43.8637.01



43.8638.01



43.8639.01



43.8640.01



43.8641.01

- Шпатели для цемента
- Шпатели для цементу
- Spatules à ciment
- Espátulas para cemento
- Zementspatel
- ملاعق الأسمنت

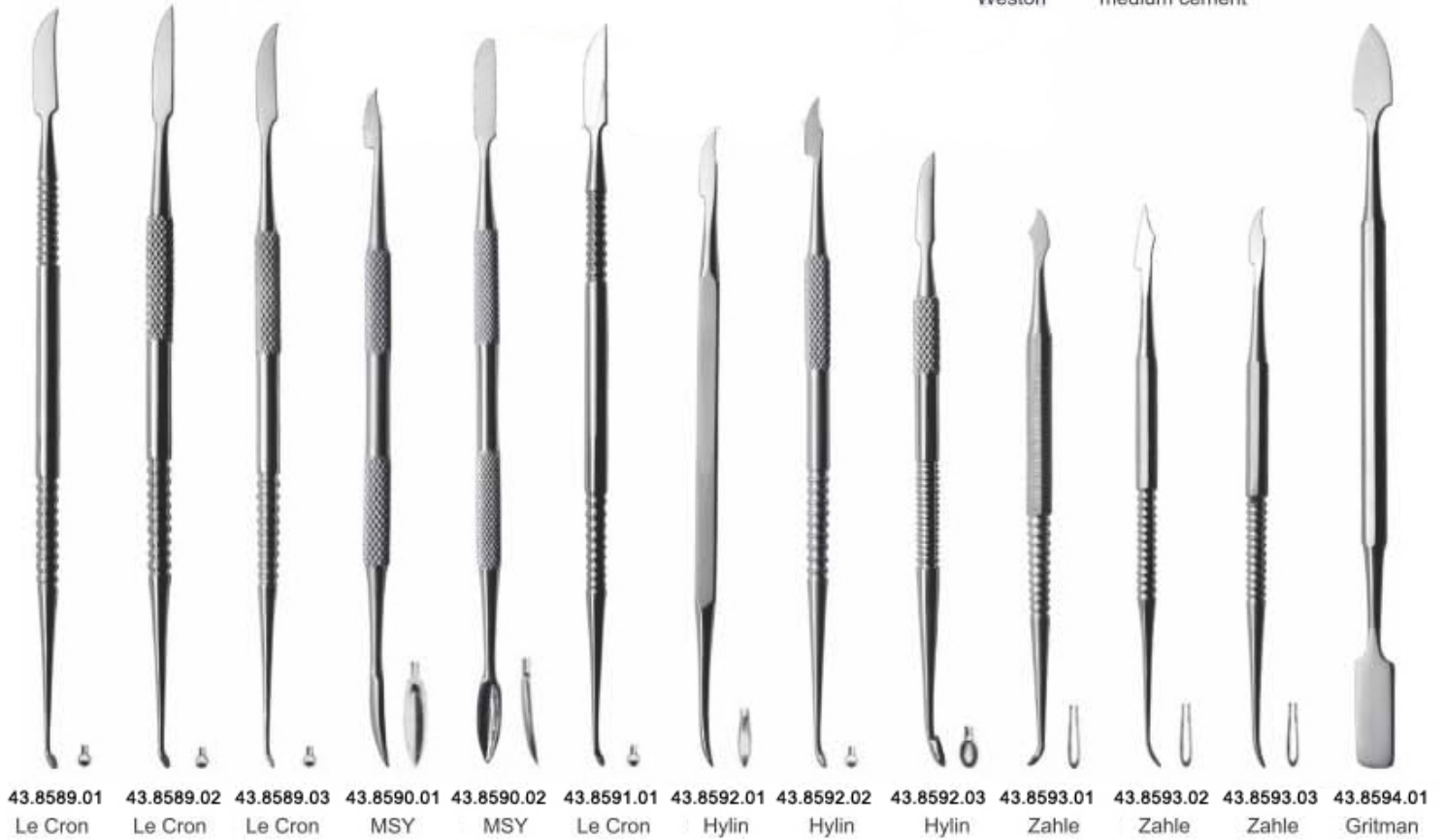
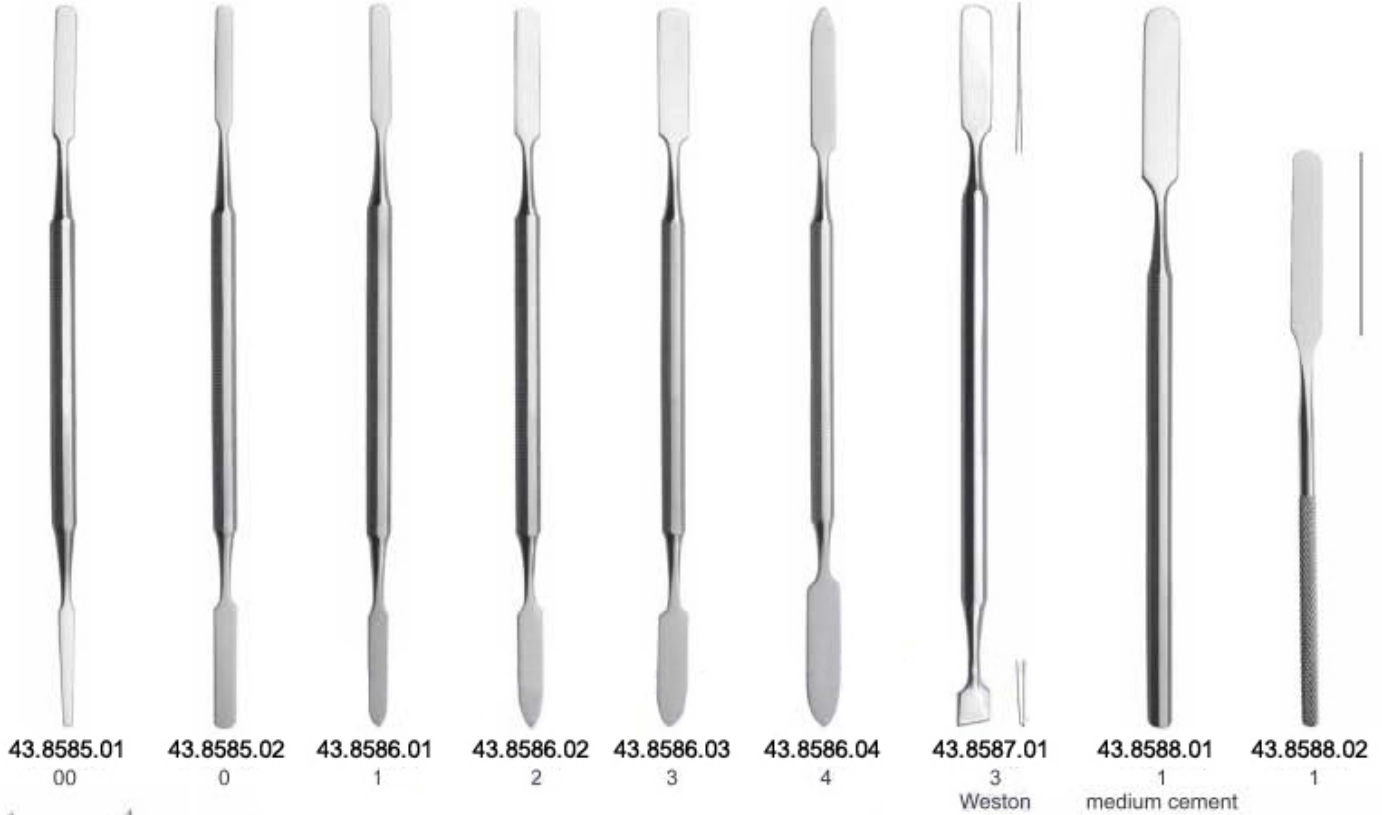

- Ножи для воска
  - Couteaux a cire
  - Wachsmesser
- Ножі для воску
  - Cuchillos para cera
  - المسكين الشمع

ALGinate, PLASTER SPATULAS, WAX KNIVES PLASTER FOR KNIVES & PLASTER SHEAR



**43.8595.05**  
Wooden Handle  
Fig. 5  
21.5 cm



**43.8595.07**  
Wooden Handle  
Fig. 7  
19.5 cm curved



**43.8595.08**  
Wooden Handle  
Fig. 8  
20 cm curved



**43.8595.09**  
Wooden Handle  
Fig. 9  
22.5 cm curved



**43.8596.01**  
Hook Knives



**43.8597.01**  
Fig. 1  
Lessmann  
12.5 cm



**43.8597.02**  
Fig. 2  
Lessmann  
17 cm



**43.8598.01**  
Fig. 1  
with small spoon  
12.5 cm



**43.8598.02**  
Fig. 2  
with large spoon  
17 cm



**43.8599.01**  
Bacolite Handle  
Wax Knives,  
Small



**43.8599.02**  
Bacolite Handle  
Wax Knives,  
Large



**43.8600.01**  
Wooden Handle  
Wax Knives,  
Small



**43.8600.02**  
Wooden Handle  
Wax Knives,  
Large



**43.8601.01**  
Plaster Knife



**43.8602.01**  
Fig. 1  
17 cm



**43.8602.03**  
Fig. 3  
16 cm



**43.8602.04**  
Fig. 4  
16 cm



**43.8603.01**  
Special Inox  
19.5 cm

- Артикуляторы
- Artocilar
- Artikulations

- Артикулятори
- Articular
- ارتیکولاتورس



43.8607.01

**Technical Datas:**

Intercondylar distance	120 mm.
condylar inclination	fixed at 30°
Bennet angle	fixed at 7°
Incisal table inclination	10°
Distance between mounting plates	85 mm.
Weight	400 gr.
Opening (item 5000)	125°
Opening (item 5010)	180°



43.8607.02

**Technical Datas:**

Intercondylar distance	110 mm.
condylar inclination	fixed at 30°
Bennet angle	fixed at 7°
Incisal table inclination	flat
Distance between mounting plates	85 mm.
Weight	450 gr.
Opening	180°



43.8608.01

Stainless Steel Finishing

43.8608.02

Royal Blue



43.8609.01



43.8610.01



43.8611.01



43.8612.01



43.8613.01



43.8614.01



43.8615.01



43.8616.01



43.8617.01

 43.8618.01  
 Nakawalni  
 Dental Laboratory  
 Instrument

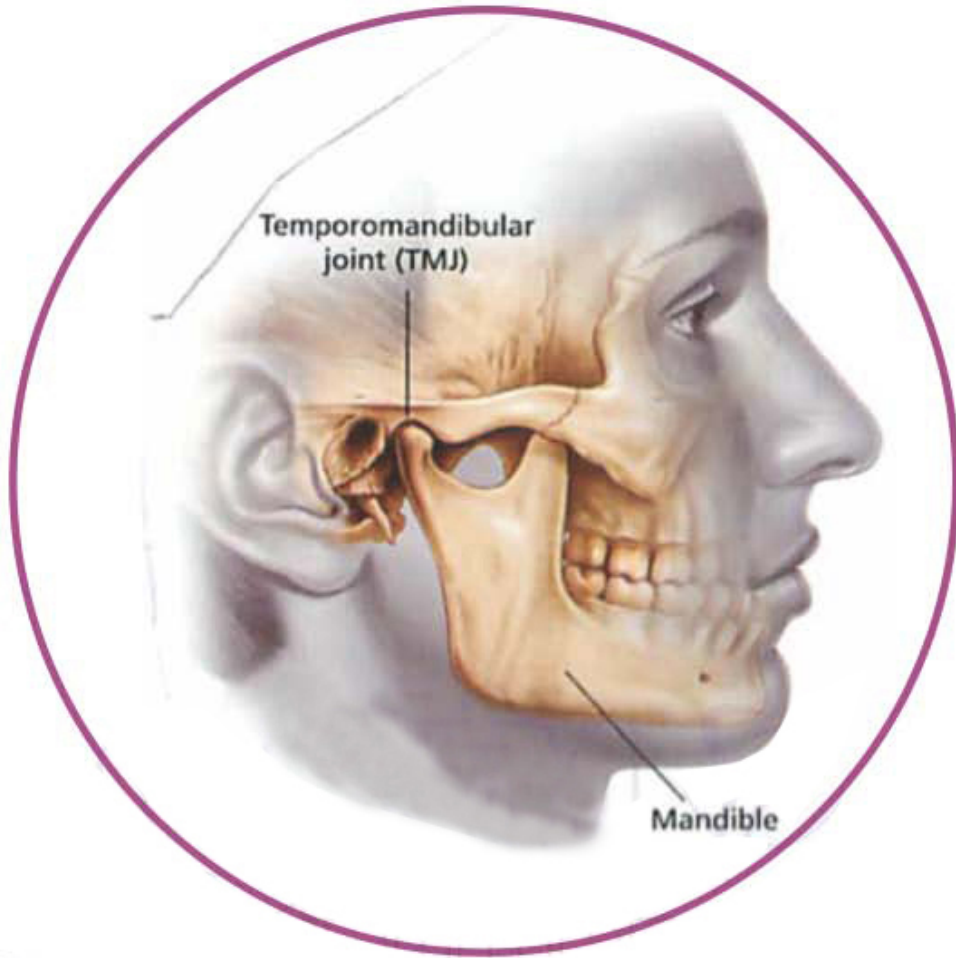



- Роторасширители
- Ecarteurs - Ouvre-bouches
- Vestibulumabhalter / Mundspanner
- Роторозширювачі
- Separadores - Abre-bocas
- الكاشطات - الكمامات الفم



**44.8701.11**  
Mouth Gag Molt  
11 cm for (Children)



**44.8701.14**  
Mouth Gag Molt  
14 cm for (Adults)



**Cheek Retractor**  
**44.8702.14** 140 mm  
**44.8702.18** 180 mm



**Cheek Retractor**  
**44.8703.14** 140 mm



**44.8704.01**  
Wangen Holder,  
vestibule  
15 cm, with or without



**44.8704.02**  
Wangen Holder,  
vestibule 15 cm, with  
or without lip protection,



**44.8705.17**  
Wangen Holder  
Wangen holder with dual  
function, 17 cm,



**Cheek Retractor**



**44.8706.14**  
140 mm



**44.8706.15**  
150 mm



- Роторасширители
- Ecarteurs - Ouvre-bouches
- Vestibulumabhalter / Mundspanner
- Роторозширювачі
- Separadores - Abre-bocas
- الكمامات-الكمامات الفم



Fig. 1  
weitlaner  
10.5cm

44.8707.10  
44.8707.13



Fig. 2  
weitlaner  
13.5cm

44.8708.10  
44.8708.13



44.8711.01  
Stainless Steel  
Double  
Ended Cheek  
Retractors



44.8711.02  
Stainless Steel  
Single  
Ended Cheek  
Retractors



Weitlander  
44.8709.11 11cm  
44.8709.12 13cm  
44.8709.13 15cm

44.8709.12  
44.8709.13



Jennings  
44.8710.11 11cm  
44.8710.13 13cm  
44.8710.15 15cm

44.8710.13  
44.8710.15



44.8712.12  
Denhard  
12 cm



44.8713.16  
Roser-König  
16 cm



44.8714.19  
Roser-König  
19 cm

**Wound, Bendable**  
Retractor, individually or as saving kit!

- Ранорасширители
  - Ecarteurs
  - Wundhaken
- Ранорозширювачі
  - Separadores
  - الكاشحات



**44.8715.01**  
Cheek Retractor  
Long



**44.8715.02**  
Cheek Retractor  
Long



**44.8715.03**  
Cheek Retractor  
Long



**Retractor with Ergo Grip**  
**44.8716.24** 24 cm,  
ergonomic handle,



**44.8717.20**  
Cheek Retractors,  
Retractor Ivory  
Width adjustable  
& fixable, 20 cm,



**Cheek Retractors, tongue depressors**  
**44.8718.19** 19 cm



**Cheek Retractors, Minnesota**  
**44.8719.16** 16 cm



**Cheek Retractors,**  
**44.8720.20** 20 cm  
easy to bend  
by hand,



**Cheek Retractors, retractor and tongue pushers BISHOP with comfortable margin,**  
**44.8721.16** 16 cm,



**Retractors Cheek retractor combination**  
Combination,  
**44.8722.25** 25 cm,

- Ранорасширители
- Ecarteurs
- Wundhaken
- Ранорозширювачі
- Separadores
- الكاشحات



**44.8723.45**  
Retractors, Unique  
Length 175 mm,  
angled 45 °



**44.8723.90**  
Retractors, Unique  
Length 175 mm,  
angled 90°



**44.8724.16**  
Retractors  
16cm



**44.8724.19**  
Retractors  
19cm



**44.8725.16**  
Retractors, Mini-Langenbeck  
16 cm, hooks 22 mm,



**44.8726.21**  
Retractors, Cheek  
retractors combination  
21 cm, 2



**44.8727.08**  
Mini Retractor  
about 8 cm,



**44.8728.17**  
Retractors  
17 cm, hooks 22 mm



**44.8729.01**

Retractors, surgical-flat  
surgically-flat, 21 cm, hook  
30x16 mm,



**44.8729.02**

Retractors, surgical-flat  
surgically-flat, 21 cm, hook  
42x11 mm



**44.8729.03**

Retractors, surgical-flat  
surgically-flat, 21 cm, hook  
63x12 mm,



Retractors, surgical-flat  
surgically-flat, 21 cm, hook  
**44.8730.30** 30x16 mm,  
**44.8730.42** 42x11 mm  
**44.8730.63** 63x12 mm,



Retractors, Langenbeck  
21 cm, hook

**44.8731.01** 30x11 mm  
**44.8731.02** 30x16 mm,



**44.8732.01**  
Retractors  
21 cm,



**44.8733.12**  
Farabeuf  
(120 X 12mm  
Set of 2 pices)



**44.8734.01**  
Retractor Seldin



**44.8735.14**  
FELDMAN  
RETRACTOR  
5-1/2", 14cm

- Ранорасширители
- Ecarteurs
- Wundhaken
- Ранорозширювачі
- Separadores
- الكاشحات

- Ножницы десневые
- Ciseaux a gencives
- Zahnfleischscheren

- Ножиці для ясен
- Tijeras para encias
- مقص صمغ



44.8736.01  
Iris  
115mm  
Straight



44.8736.02  
Iris  
115mm  
Curved



44.8737.01  
Goldman-Fox  
130mm  
Saw edge, straight



44.8737.02  
Goldman-Fox  
130mm  
Saw edge, Curved



44.8738.11  
La Grange  
115mm  
Saw edge, double Curved



Mayo  
44.8739.14 140mm  
44.8739.17 170mm  
44.8739.23 230mm  
Straight



Mayo  
44.8740.14 140mm  
44.8740.17 170mm  
44.8740.23 230mm  
Curved



Metzenbaum  
44.8741.14 145mm  
44.8741.18 180mm  
44.8741.20 200mm  
Straight



Metzenbaum  
44.8742.14 145mm  
44.8742.18 180mm  
44.8742.20 200mm  
Curved



44.8743.01  
Kelly  
160mm  
Straight



44.8743.02  
Kelly  
160mm  
Curved



44.8744.01  
Iris  
115mm  
Straight



44.8744.02  
Iris  
115mm  
Curved



44.8745.11  
La Grange  
115mm  
Double Curved



44.8746.01  
Goldman-Fox  
130mm, Straight



44.8746.02  
Goldman-Fox  
130mm, Curved



44.8747.16  
Kelly  
160mm, Curved



44.8747.01  
Iris  
115mm, Straight



44.8747.02  
Iris  
115mm, Curved



44.8748.09  
Micro Iris  
90mm, Curved

- Ножницы десневые
- Ciseaux a gencives
- Zahnfleissscheren

- Ножиці для ясен
- Tijeras para encias
- مقص صمغ

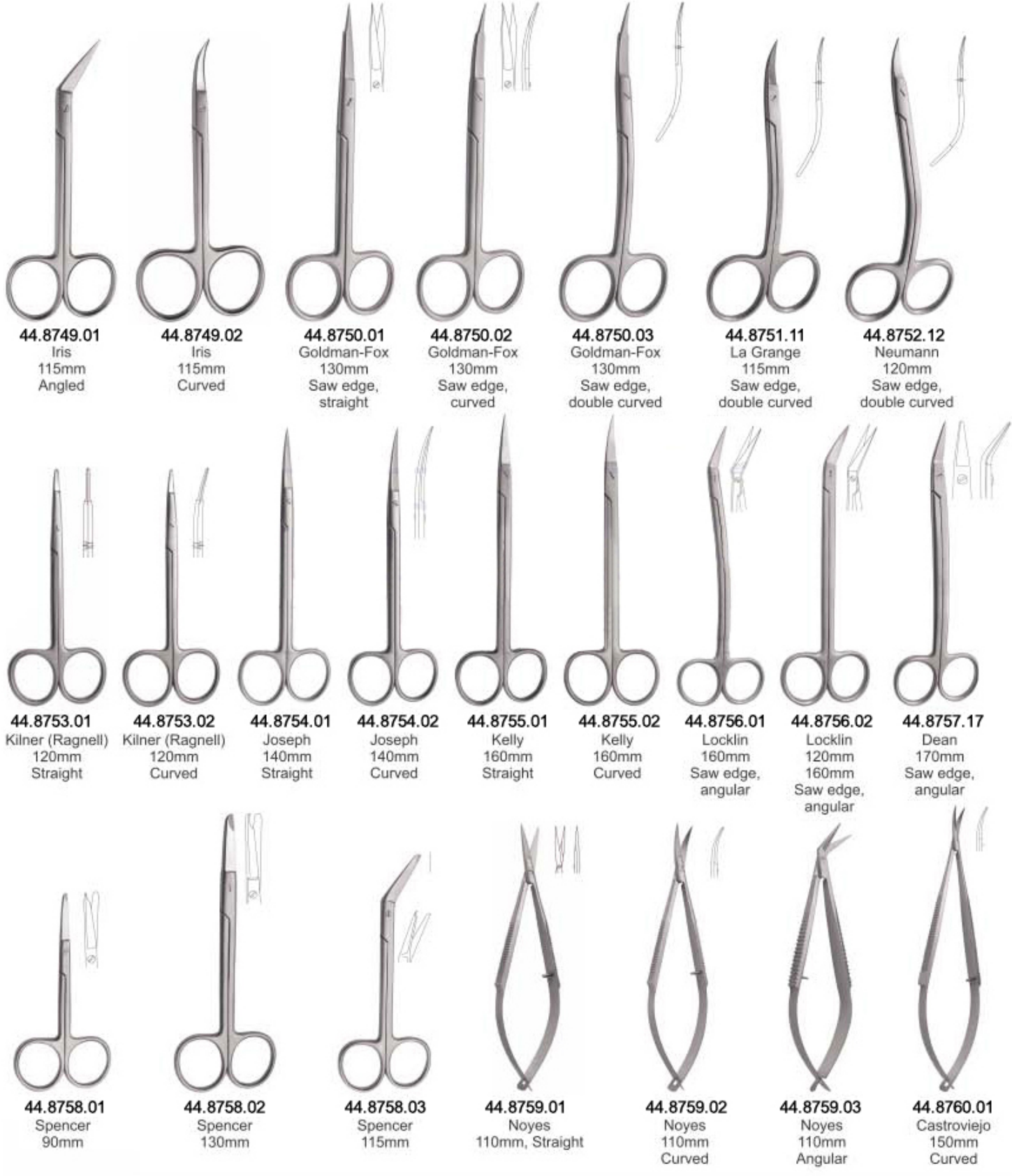

<b>44.8749.01</b> Iris 115mm Angled	<b>44.8749.02</b> Iris 115mm Curved	<b>44.8750.01</b> Goldman-Fox 130mm Saw edge, straight	<b>44.8750.02</b> Goldman-Fox 130mm Saw edge, curved	<b>44.8750.03</b> Goldman-Fox 130mm Saw edge, double curved	<b>44.8751.11</b> La Grange 115mm Saw edge, double curved	<b>44.8752.12</b> Neumann 120mm Saw edge, double curved
<b>44.8753.01</b> Kilner (Ragnell) 120mm Straight	<b>44.8753.02</b> Kilner (Ragnell) 120mm Curved	<b>44.8754.01</b> Joseph 140mm Straight	<b>44.8754.02</b> Joseph 140mm Curved	<b>44.8755.01</b> Kelly 160mm Straight	<b>44.8755.02</b> Kelly 160mm Curved	<b>44.8756.01</b> Locklin 160mm Saw edge, angular
<b>44.8756.02</b> Locklin 120mm Saw edge, angular	<b>44.8757.17</b> Dean 170mm Saw edge, angular	<b>44.8758.01</b> Spencer 90mm	<b>44.8758.02</b> Spencer 130mm	<b>44.8758.03</b> Spencer 115mm	<b>44.8759.01</b> Noyes 110mm, Straight	<b>44.8759.02</b> Noyes 110mm Curved
<b>44.8759.03</b> Noyes 110mm Angular	<b>44.8760.01</b> Castroviejo 150mm Curved					

- Иглодержатели
- Porte-aiguilles
- Nadelhalter

- Голкотримачі
- Porta-agujas
- اصحاب إبرة



44.8761.01

130mm  
Straight44.8762.13  
44.8762.14  
44.8762.18Mayo Mayo  
130mm 130mm  
160mm 160mm  
180mm 180mm  
Straight Curved44.8763.14  
44.8763.20Mayo Mayo  
140mm 140mm  
200mm 200mm  
Straight Curved44.8764.14  
44.8764.20Metzenbaum  
145mm 145mm  
200mm 200mm  
Straight Curved

44.8765.01

Beebee  
110mm  
Saw edge,  
straight

44.8765.02

Beebee  
110mm  
Saw edge,  
curved

44.8766.01

Beebee  
110mm  
Saw edge, straight

44.8766.02

Beebee  
110mm  
Saw edge, curved

44.8767.01

Universal  
120mm  
Saw edge

44.8767.02

Universal  
120mm

Crile

44.8768.13 130mm  
44.8768.15 150mm  
44.8768.18 180mm

44.869.13

Halsey  
130mm44.8770.13  
Baumgartner  
130mm44.8771.12  
Derf  
120mm44.8772.15  
Delicate  
150mm44.8773.13 130mm  
44.8773.16 160mm  
44.8773.18 180mm  
44.8773.20 200mm44.8774.01  
Crile-Wood  
150mm  
straight44.8774.02  
Crile-Wood  
150mm  
curved



- Иглодержатели
- Porte-aiguilles
- Nadelhalter

- Голкотримачи
- Porta-agujas
- اصحاب ابرة



Castroviejo  
44.8775.13 130mm  
44.8775.15 150mm  
44.8775.18 180mm



44.8776.13  
Halsey  
130mm



44.8776.13  
Baumgartner  
130mm



44.8777.12  
Derf  
120mm



44.8778.15  
Delicate  
150mm



44.8779.17  
Adson  
170mm



Mayo-Hegar  
44.8780.13 130mm  
44.8780.16 160mm  
44.8780.18 180mm  
44.8780.20 200mm



44.8781.15  
Crile-Wood  
150mm



Castroviejo  
44.8782.14 str 140mm cvd  
44.8782.18 str 180mm cvd



Olsen-Hegar Needle  
Holder With Scissors  
44.8783.14 140mm



Gillies Needle  
Holder With Scissors  
44.8784.16 160mm



Mathieu  
44.8785.14 140mm  
44.8785.17 170mm



Castroviejo  
44.8786.14 str 140mm cvd  
44.8786.18 str 180mm cvd



Olsen-Hegar Needle  
Holder With Scissors  
44.8787.14 140mm



Gillies Needle  
Holder With Scissors  
44.8788.16 160mm

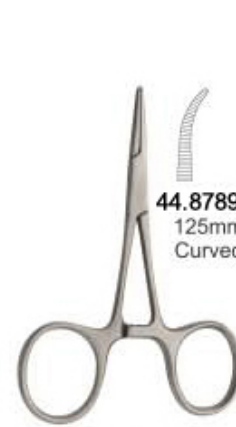

Hartmann (Baby  
Mosquito)  
44.8789.09 90mm straight

44.8789.12  
125mm  
Curved



Halstead Mosquito  
44.8790.01 125mm  
Straight

44.8790.02  
Curved

- Зажимы артериальные, зажимы для салфеток
- Pincés hemostatiques, Pincés a compreses
- Arterienklemmen, Tuyschklemmen
- Затискачі артеріальні, затискачі для серветок
- Pinzas hemostaticas, Pincés para compresas
- الملقط هيموستاتيک المشابك منشفة



Halstead Mosquito 1x2  
44.8791.01 125mm  
straight



Kelly  
44.8792.01 140mm  
straight



Rochester-Pean  
44.8793.14 140mm  
44.8793.16 160mm  
44.8793.18 180mm  
44.8793.20 200mm  
straight



Rochester-Kocher 1x2  
44.8795.14 140mm  
44.8795.16 160mm  
44.8795.18 180mm  
44.8795.20 200mm  
straight



44.8797.01  
Kelly-Rankin  
160mm  
straight



Lorna  
44.8798.10 100mm  
44.8798.13 130mm



Allis-Baby 3:4  
44.8799.03 150mm



Allis 4:5  
44.8799.04 200mm



Allis 6:7  
44.8799.06 200mm



Backhaus  
44.8800.14 140mm  
Not-perforating and  
not-damaging



44.8801.13  
Backhaus  
130mm



44.8802.85  
Backhaus  
85mm



44.8803.90  
Jones  
90mm



Gross Maier  
Dressing Forceps  
44.8804.01 200mm straight

44.8804.02  
curved



Foerster  
Dressing Forceps  
44.8805.20 200mm



Young  
Tongue Forceps  
44.8806.17 170mm

Spare rubber



Collins  
Tongue Forceps  
44.8807.17 170mm



**44.8808.18**

On request the Content of the rubber dam kit can be changed with other instruments.

**Content:**

- 01 Anisworth
- 02 Brewer
- 03 Clamps Stand
- 04 Denture Plate
- 05 Rubber Dam Frame
- 06 Rubber Dam Box Lower Case
- 07 Rubber Dam Box Upper Case
- 08 Rubber Dam Clamp Fig. 212
- 09 Rubber Dam Clamp Fig. 211
- 10 Rubber Dam Clamp Fig. 8
- 11 Rubber Dam Clamp Fig. 8A
- 12 Rubber Dam Clamp Fig. 14
- 13 Rubber Dam Clamp Fig. 14A
- 14 Rubber Dam Clamp Fig. 0
- 15 Rubber Dam Clamp Fig. 00
- 16 Rubber Dam Clamp Fig. 2
- 17 Rubber Dam Clamp Fig. 2A
- 18 Rubber Dam Clamp Fig. 7

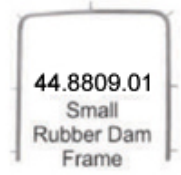

**44.8809.01**  
Small  
Rubber Dam  
Frame

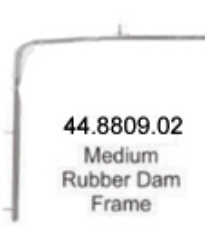

**44.8809.02**  
Medium  
Rubber Dam  
Frame

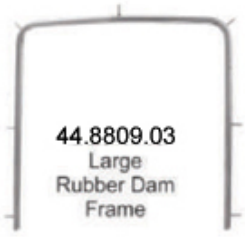

**44.8809.03**  
Large  
Rubber Dam  
Frame



**44.8810.01**  
Brewer



**44.8810.02**  
Stockes



**44.8810.03**  
Palmer



**44.8811.01**  
Ivory light weight



Anisworth  
**44.8812.01**



Anisworth  
**44.8812.02**



Anisworth  
**44.8812.03**



Ivory  
**44.8813.01**



**44.8813.02**  
Separating  
Elastic Plier

- Кламмера для коффердама
- Crampons pour digue
- Kofferdam Klammern
- Кламмера для коффердама
- Grapas para dique de caucho
- المشابك السد المطاط

 44.8814.01  
 Fig. 15

 44.8814.02  
 Fig. 18

 44.8814.03  
 Fig. 24

 44.8814.04  
 Fig. 25

 44.8814.05  
 Fig. 26

 44.8814.06  
 Fig. 28

 44.8814.07  
 Fig. 30

 44.8814.08  
 Fig. 31

 44.8814.09  
 Fig. 51

 44.8814.10  
 Fig. 138

 44.8814.11  
 Fig. 139

 44.8814.12  
 Fig. 200

 44.8814.13  
 Fig. 201

 44.8814.14  
 Fig. 202

 44.8814.15  
 Fig. 203

 44.8814.16  
 Fig. 204

 44.8814.17  
 Fig. 205

 44.8814.18  
 Fig. 3

 44.8814.19  
 Fig. W3

 44.8814.20  
 Fig. 4

 44.8814.21  
 Fig. 56A

 44.8814.22  
 Fig. 7

 44.8814.23  
 Fig. 7A

 44.8814.24  
 Fig. 8

 44.8814.25  
 Fig. 8A

 44.8814.26  
 Fig. W8A

 44.8814.27  
 Fig. 10

 44.8814.28  
 Fig. 11

 44.8814.29  
 Fig. 12A

 44.8814.30  
 Fig. 13A

 44.8814.31  
 Fig. 14

 44.8814.32  
 Fig. 14A

 44.8814.33  
 Fig. 14AN

 44.8814.34  
 Fig. 22

 44.8814.35  
 Fig. 27

 44.8814.36  
 Fig. 207

 44.8814.37  
 Fig. 29

 44.8814.38  
 Fig. 206

 44.8814.39  
 Fig. 208

 44.8814.40  
 Fig. 209

 44.8814.41  
 Fig. 1

 44.8814.42  
 Fig. 1A

 44.8814.43  
 Fig. 2

 44.8814.44  
 Fig. 2A

 44.8814.45  
 Fig. W2A

 44.8814.46  
 Fig. 0

 44.8814.47  
 Fig. 00

 44.8814.48  
 Fig. 210

 44.8814.49  
 Fig. 211

 44.8814.50  
 Fig. 212

 44.8814.51  
 Fig. 6

 44.8814.52  
 Fig. 9

 44.8814.53  
 Fig. N06

 44.8814.54  
 Fig. U67

 44.8814.55  
 Fig. 214

 44.8814.56  
 Fig. P1

 44.8814.57  
 Fig. P2

 44.8814.58  
 Fig. G-1

 44.8814.59  
 Fig. G-2

 44.8814.59  
 Fig. G-2

- Инструменты для удаления коронок
- Arrache-couronnes
- Teleskopkronenzangen
- Инструменты для удаления коронок
- Arranca-corona
- مزيلات التاج



**44.8815.01**  
Crown Spreaders



**44.8816.04**  
Mershon  
14 cm  
Band Pusher



**44.8817.01**  
Fig. 0



**44.8818.01**  
Manual Crown Remover



**44.8819.03**  
Complete with 3 tips  
and tightening keys

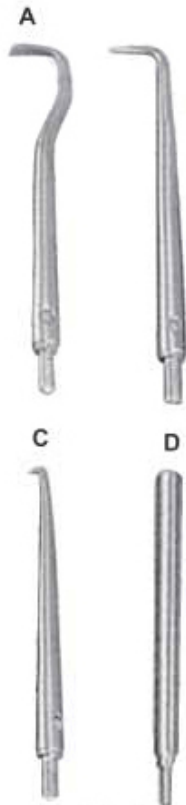

semi-automatic crown  
& bridge remover



**44.8820.01**



**44.8821.03**

Manual Crown Remover



- Матрицедержатели
- Porte Matrices
- Matrizenhalter

- Матрицеуtrimувачи
- Porta Matrices
- مصلفة الخدم



44.8822.05  
Fig. 5  
Ivory 8  
5 cm



44.8822.06  
Fig. 6  
Ivory 8  
6 cm



44.8822.07  
Fig. 7  
Ivory 8  
7 cm



44.8823.01  
Fig. 1  
Tofflemire-Universal



44.8823.02  
Fig. 2  
Tofflemire-Junior



44.8823.03  
Fig. 3  
Tofflemire-Senior

Siqveland Retainers



44.8824.01  
Narrow



44.8824.02  
Wide

Amalgam Well



44.8825.01  
Stainless Steel  
Amalgam Well



44.8826.01  
Ivory 12



44.8826.02  
Ivory 1



44.8826.03  
Ivory



44.8827.01  
Elliot

- Инструментъ для амальгамы

• Instruments pour amalgame

• Amalgamis/instrumente
- Инструменти для амальгами

• Instrumentos para amalgama

• الصكوك المنغم
- Ручки для скальпелей

• Manches de bistouris

• Skalpellgriffe
- Ручки для скальпелів

• Mangos de bisturi

• مشرط مقبض



**44.8828.02**  
Fig. 10  
165mm  
English pattern



**44.8829.02**  
Fig. 1  
185mm  
German pattern



**44.8830.02**  
Fig. 1  
150mm  
Swiss pattern



**44.8831.01**  
Fig. 1  
150mm



**44.8831.02**  
Fig. 2  
150mm, 45°



**44.8831.03**  
Fig. 3  
140mm, 90°



**44.8832.03**  
Fig.3  
5" (12.7cm)



**44.8834.03**  
Fig.3G  
5" (12.7cm)



**44.8835.04**  
Fig.4  
5 1/2" (13.7cm)



**44.8836.06**  
6 Way Adjustable Angled  
Scalpel Handle



Locks At 90°, 60°, 30°,  
Straight, 120°, 150°, 180°,  
Angles

AMALGAM CARRIERS

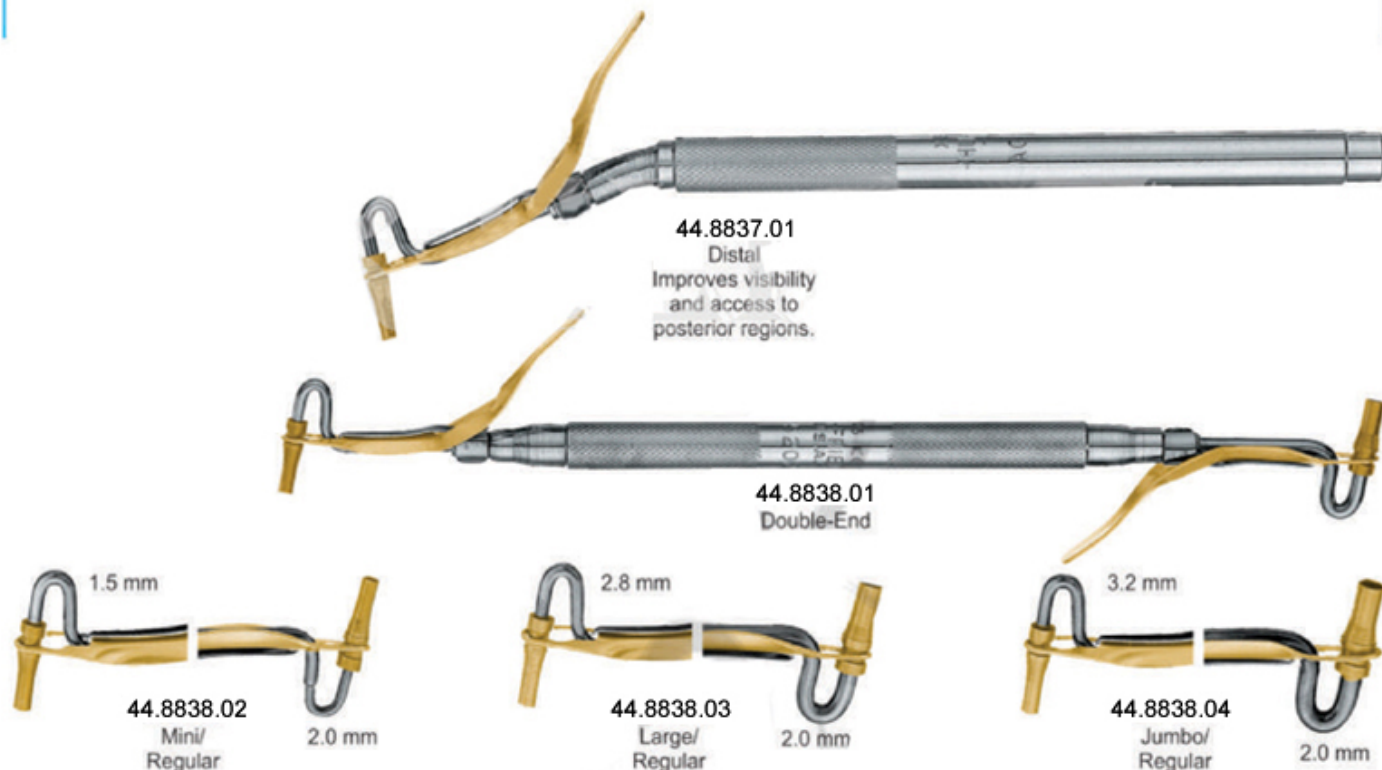

TIP SIZES FOR DOUBLE-END





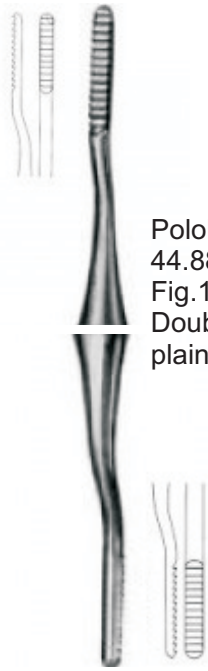

**Polokoff Bone File**  
44.8845.01  
Fig.1  
Double ended,  
plain serrations



44.8846.01  
Miller-Colburn  
Fig.1x  
cross-cut



44.8846.02  
Miller-Colburn  
Fig.2x  
cross-cut



44.8846.03  
Miller-Colburn  
Fig.3x  
cross-cut



**Bone File**  
44.8845.10  
fig.10



**Bone File**  
44.8845.12  
Fig.12A



**Bone File**  
44.8845.14  
Fig.12CA



**Bone file**  
44.8845.33  
Fig.33



44.8846.45  
Miller Bone File  
Fig#45



44.8846.52  
Miller Bone File  
Fig#52



44.8846.64  
Miller Bone File  
Fig#64



44.8846.21  
Miller Bone File  
Fig#21



44.8847.01  
Wahl Bone File  
Fig#1



44.8847.02  
Wahl Bone File  
Fig#2



47.8847.12  
Howard Bone File  
Fig#12



47.8847.67  
Howard Bone File  
Fig#67

**ROOT PLANNING FILES**



**44.8842.01**  
Kramer-Nevins  
Bone Chisel



**44.8842.02**  
Kramer-Nevins  
Bone Chisel



**44.8843.18**  
Molt 18.5cm  
Auto Clavable  
Plastic Tips.



**44.8844.18**  
Mead 18.5cm  
Non Auto Clavable  
Plastic Tips.



**44.8845.01**  
Miller



**44.8845.02**  
Miller

**BONE FILES**



**44.8846.01**  
Miller 21



**44.8846.02**  
Miller 1X  
cross cut



**44.8846.03**  
Miller 2X  
cross cut



**44.8846.04**  
Miller 52



**44.8847.01**  
Wahl 1

- Инструменты пародонтологические
- Instruments pour la parodontologie
- Instrumente für die Parodontologie
- Инструменти пародонтологічні
- Instrumentos para periodoncia
- الصكوكه اللثة

## PERIOSTEEL ELEVATORS

44.8848.01  
BUSER44.8849.10  
Ohl 1044.8850.09  
Howard 9H44.8851.01  
Freer44.8852.15  
Freer 1544.8853.16  
Freer 1644.8854.09  
Molt 944.8855.09  
Allen 9A44.8856.03  
Prichard 344.8857.23  
Seldin 2344.8858.14  
Goldman-Fox  
1444.8859.24  
P 24G44.8860.01  
Raspator, Raspatory  
Length 175 mm,44.8860.02  
Raspator, Raspatory  
Length 175 mm,44.8860.03  
Raspator, Raspatory  
Length 175 mm,44.8861.01  
Raspator, Williger  
Length 170 mm, different widths  
(4 mm, 5 mm or 7 mm),44.8861.02  
Raspator, Williger  
Length 170 mm, different widths  
(4 mm, 5 mm or 7 mm),44.8861.03  
Raspator, Williger  
Length 170 mm, different widths  
(4 mm, 5 mm or 7 mm),



• QUALITY - ЯКІСТЬ • PRECISION - ТОЧНІСТЬ • ACCURACY - ПРАВИЛЬНІСТЬ • DURABILITY - ЗНОСОСТІЙКІСТЬ



**STYLE A**

- Super-sharp diamond-based cutters
- smooth ultra-polished and contoured edges
- brilliant corrosion resistant stainless steel finish
- superior T12 stainless steel end inserts
- sliding lock joint for balance & precision alignment

**STYLE B**

- Super-sharp diamond-based cutters
- smooth ultra-polished and contoured edges
- brilliant corrosion resistant stainless steel finish
- superior T12 stainless steel end inserts
- sliding lock joint for balance & precision alignment



**45.8901.01**  
Aluminum Height Gauge 0.22



**45.8901.02**  
Aluminum Height Gauge 0.18



**45.8901.03**  
Height Gauge Movable



**45.8901.04**  
Bone Bracket Gauge



**45.8902.01**  
Endo Finger Ruler Span Measure Scale



**45.8902.02**  
Endo Finger Ruler Span Measure Scale



**45.8902.03**  
Endo Finger Ruler Span Measure Scale



**45.8904.01**  
Compass De Willis



**45.8905.01**  
Bone Thickness Gauge 40mm, 180mm



**45.8905.02**  
Osteometer Measuring Forceps



**45.8906.01**  
Bracket Placer Tweezers (Extra Fine Tip)



**45.8907.01**  
Direct Bonding Bracket Holders 135mm



**45.8907.02**  
Direct Bonding Bracket Holders 136mm



**45.8907.03**  
Direct Bonding Bracket Holders 135mm



**45.8907.04**  
Direct Bonding Bracket Holders 140mm



**45.8907.05**  
Direct Bonding Bracket Holders 140mm



**45.8907.06**  
Direct Bond Bracket Holder Tweezers Small Tip



**45.8907.07**  
Exact Bracket Holder Tweezers



**45.8908.01**  
Bracket Tweezers Slot Aligner



**45.8908.02**  
Deluxe Bracket Holder



**45.8908.03**  
Deluxe Bracket Holder Tweezers



**45.8908.04**  
Deluxe Bracket Holder Tweezers



**45.8909.01**  
Bracket Placing Tweezers



**45.8909.02**  
Easy Access Tweezers



**45.8909.03**  
Easy Ecess Tweezers



**45.8909.04**  
Slipper Tweezers

- Инструменты ортодонтические
- Instrumentos Ortodonticos
- Orthodontische Instrumente

- Инструменти ортодонтични
- Instruments Orthodontiques
- أدوات تقويم الأسنان



**45.8910.01**  
Band seater auto cleavable



**45.8911.01**  
Ortho light scaler double ended



**45.8911.02**  
Ortho light scaler double ended



**45.8911.03**  
Ortho light scaler double ended



**45.8912.01**  
Twiel-on elastic module instrument



**45.8912.02**  
Twiel-on elastic module instrument



**45.8913.01**  
Schure Band Seater



**45.8914.01**  
Ortho light scaler



**45.8914.02**  
Ortho light scaler

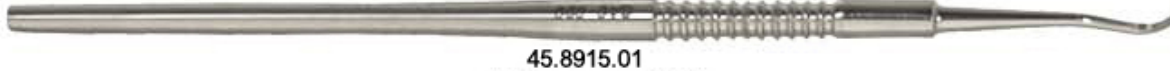

**45.8915.01**  
Ortho light scaler heavy



**45.8916.01**  
Ortho instrument



**45.8916.02**  
Ortho instrument



**45.8917.01**  
Ortho Light Band Pusher Scaler

- Инструменты ортодонтические
- Instrumentos Ortodonticos
- Orthodontische Instrumente
- Инструменти ортодонтични
- Instruments Orthodontiques
- أدوات تقويم الأسنان



**45.8918.01**  
Ortho Light double ended  
ligature director



**45.8918.02**  
Ortho Light double ended  
ligature director scaler



**45.8919.01**  
Ortho Light double ended ligature scaler director tivate coil spring  
are remove modules with one instruments



**45.8920.01**  
Ortho band pusher scaler



**45.8921.01**  
Ortho Light Band Pusher Scaler



**45.8922.01**  
Ortho ligature director single ended



**45.8923.01**  
Ortho Light double ended ligature  
director scaler



**45.8924.01**  
Ortho Light double ended ligature scaler/director  
tivate coil spring are remove modules with one instruments



**45.8925.01**  
Ortho Light double ended ligature director



**45.8926.01**  
Ortho Light Ligature Director Scaler



**45.8927.01**  
Ortho light ligature director double ended



**45.8928.01**  
Double ended cement spatula



**45.8929.01**  
Ortho light scaler single ended



- Щипцы для ортодонтии и протезирования
- Pincers pour l'orthodontie et la prothèse
- Zangen für Kieferorthopädie und Prothetik
- Щипці для ортодонції та протезування
- Alicates para ortodoncia y prótesis
- كمانشة لتقويم الأسنان بروسثیتیس

## BOX JOINT PLIERS

**45.8930.13**  
Universal Dolphin Style  
Wire Bending & cutting pliers



**45.8931.13 Band Removing Plier**  
The curved blade of the band removing plier can strip easily and gently remove directly to the tooth. Length 130mm



**45.8932.13**  
Tweed Loop forming Pliers



**45.8933.13 How Plier curved**  
Universally usable tool for the multiband technology for wires up to .028". Length 130mm



**45.8934.13 How Plier**  
Universally usable tool for the multiband technology for wires up to .028". Length 135mm



**45.8935.13**  
Nance Loop forming Pliers



**45.8936.13**  
Bracket Removing Plier curved  
Bracket Removing Plier curved for easy removal of brackets in the posterior region. Length 130mm



**45.8937.13**  
Young Wire Bending & Loop Forming Pliers



**45.8938.13**  
Wire Bending & Loop Forming Pliers



**45.8939.13**  
Adams, small wire bending and loop forming Pliers



**45.8990.13**  
Bracket Removing Plier Round Box  
Bracket removing plier for comfortable and quick removal of the brackets. Length 135mm



**45.8991.14**  
Weingart Plier medium  
Weingart plier that are ideal due to their curved tip for setting sheets and is capable of bending the ends. Length 145mm



- Щипцы для ортодонтии и протезирования
- Pincers pour l'orthodontie et la prothèse
- Zangen für Kieferorthopädie und Prothetik
- Щипці для ортодонції та протезування
- Alicates para ortodoncia y prótesis
- معاشة لتقويم الأسنان بروستييس

**BOX JOINT PLIERS**

**45.8992.12 Adams Plier Round Box**

Adams pliers for bending wire arches and bends right angles for wires up to .022", .025 tip to beak. Length 125mm



**45.8998.12 Adams Plier**

Adams pliers for bending wire arches and bends right angles for wires up to .022", .025 tip to beak. Length 125mm

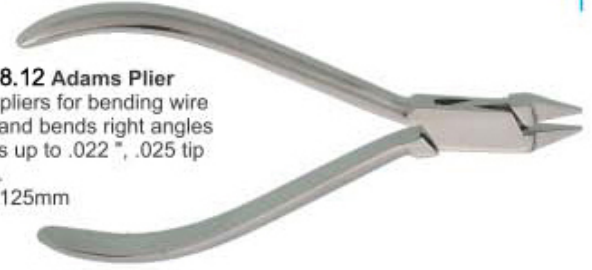

**45.8993.12**

Falcon Beak Contouring Pliers.



**45.8999.12**

Tweed Loop Formin Pliers



**45.8994.12**

wires up to 0.020" / 0.7mm.



**45.9001.12 Bird Beak Plier Standard**

Bird Beak Wire bending plier without notches, which is suitable as a universal utility tool. Length 125mm



**45.8995.12**

Johnson Contouring Pliers



**45.9002.12**

Mini Ligature cutters



**45.8996.12 Aderer**

Large wire bending and loop forming pliers



**45.9003.12 Small**

Fluch-cut distal and cutting Pliers with safety hold fitted with un-breakable, corrosion resistant and durable stainless steel tips



**45.8997.12**

Tweed / angle rectangular arch forming & Torquing pliers



**45.9004.12 Large**

Fluch-cut distal and cutting Pliers with safety hold fitted with un-breakable, corrosion resistant and durable stainless steel tips



- Щипцы для ортодонтии и протезирования
- Pincers pour l'orthodontie et la prothèse
- Zangen für Kieferorthopädie und Prothetik

- Щипці для ортодонції та протезування
- Alicates para ortodoncia y prótesis
- كماشة لتقويم الأسنان بروتيسيس

## BOX JOINT PLIERS

45.9005.12

Tweed / Angel

1.78mm (.070") wide tips arch forming and torquing pliers



45.9011.13

Contouring Plier



45.9006.12

Tweed / Angel

1.78mm (.070") wide tips arch forming and torquing pliers



45.9012.13

Bands & Crowns Plier  
in order to skirt

45.9007.12

Lingual / Palatal arch forming pliers



45.9013.13

Ligature Forming Pliers



45.9008.12

Aderer

Facebow loop forming Pliers



45.9014.13

for double back and triple back bands in 0.30" / 0.76mm &amp; 0.36" / 0.91mm lingual arch wires



45.9009.12

Waldsavhs wire bending and cutting pliers



45.9015.13

Bird Beak Wire Bending &amp; cutting pliers



45.9010.13 Aderer Plier

For the manufacturing of appliances and activation of wires for wires up to .030" .fine tip and up to .036" mean tip. Length 130mm



45.9016.14

Weingart Plier medium

Weingart plier that are ideal due to their curved tip for setting sheets and is capable of bending the ends. Length 145mm



- Щипцы для ортодонтии и протезирования
- Pincers pour l'orthodontie et la prothèse
- Zangen für Kieferorthopädie und Prothetik
- Щипці для ортодонції та протезування
- Alicates para ortodoncia y prótesis
- كمانة لتقويم الأسنان بروستييس

**L-KEY JOINT PLIERS**



**45.9015.13**  
Distal end cutter with safety hold, mini head, long handles. fitted with un-breakable, corrosion resistant and durable stainless steel tips

- 0.30 mm to 0.50 mm (.012" to .020")
- Max. 0.46 mm x 0.64 mm (.018" x .025")
- ⊗ 0.38 mm to 0.53 mm (.0155" to .0215")
- ⊗ Max. 0.53 mm x 0.64 mm (.021" x .025")



**45.9016.13**  
Flush-cut distal end cutter with safety hold fitted with un-breakable, corrosion resistant and durable stainless steel tips

- 0.30 mm to 0.50 mm (.012" to .020")
- Max. 0.46 mm x 0.64 mm (.018" to .025")



**45.9018.13**  
Soft wire and ligature cutter, Mini fitted with un-breakable, corrosion resistant and durable stainless steel tips

- ⌋ .25 mm to .38 mm (.010" to .015")



**45.9019.13**  
Soft wire and ligature cutter, standard fitted with un-breakable, corrosion resistant and durable stainless steel tips

- ⌋ .25 mm to .38 mm (.010" to .015")



**45.9020.15**  
Soft wire and ligature cutter, 15° angled fitted with un-breakable, corrosion resistant and durable stainless steel tips

- ⌋ .25 mm to .38 mm (.010" to .015")



**45.9021.13**  
Soft wire and ligature cutter, 45° angled fitted with un-breakable, corrosion resistant and durable stainless steel tips

- ⌋ .25 mm to .38 mm (.010" to .015")



**45.9022.13**  
Hard wire cutter, straight Fitted with un-breakable, corrosion resistant and durable stainless steel tips

- 0.30 mm to 0.50 mm (.012" to .020")
- Max. 0.56 mm x 0.71 mm (.022" x .028")



**45.9023.13**  
Hard wire cutter, 15° angled Fitted with un-breakable, corrosion resistant and durable stainless steel tips

- 0.30 mm to 0.50 mm (.012" to .020")
- Max. 0.56 mm x 0.71 mm (.022" x .028")



**45.9024.13**  
Hard wire cutter, 15° angled Non-autocalavable

- 0.30 mm to 0.50 mm (.012" to .020")
- Max. 0.56 mm x 0.71 mm (.022" x .028")

- Щипцы для ортодонтии и протезирования
- Pincers pour l'orthodontie et la prothèse
- Zangen für Kieferorthopädie und Prothetik
- Щипці для ортодонції та протезування
- Alicates para ortodoncia y prótesis
- كمانشة لتقويم الأسنان بروسثیتیس

## L-KEY JOINT PLIERS



**45.9025.13**  
Band removing pliers



**45.9030.13**  
Weingart-mini  
Utility Pliers

- 0.30 mm to 0.50 mm (.012" to .020")
- Max 0.56 mm x 0.71 mm (.022" x .028")



**45.9026.13**  
Bracket removing pliers angled

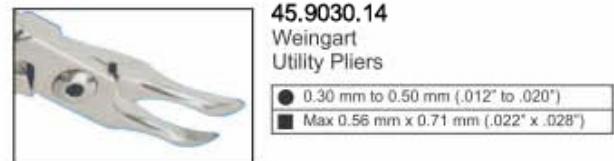

**45.9030.14**  
Weingart  
Utility Pliers

- 0.30 mm to 0.50 mm (.012" to .020")
- Max 0.56 mm x 0.71 mm (.022" x .028")



**45.9027.13**  
Bracket removing pliers straight



**45.9031.13**  
How Straight  
Utility Pliers

- 0.30 mm to 0.50 mm (.012" to .020")
- Max 0.56 mm x 0.71 mm (.022" x .028")



**45.9028.13**  
Bracket removing pliers with plastic tip

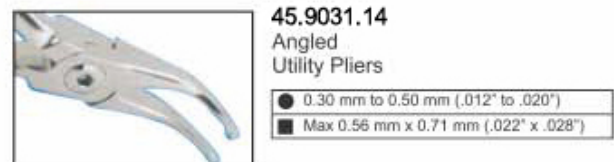

**45.9031.14**  
Angled  
Utility Pliers

- 0.30 mm to 0.50 mm (.012" to .020")
- Max 0.56 mm x 0.71 mm (.022" x .028")



**45.9029.13**  
Adhesive removing pliers



**45.9032.13**  
Wire bending and loop forming pliers  
Angled (Bird beak)

- 0.30 mm to 0.50 mm (.012" to .020")
- Max 0.56 mm x 0.71 mm (.022" x .028")

- Щипцы для ортодонтии и протезирования
- Pincas pour l'orthodontie et la prothèse
- Zangen für Kieferorthopädie und Prothetik
- Щипці для ортодонтії та протезування
- Alicates para ortodoncia y prótesis
- كمشة لتقويم الأسنان بروستیتیس

**L-KEY JOINT PLIERS**



**45.9033.13**  
Multi-purpose pliers, bird beak,  
De la rosa and cutter in one

● 0.30 mm to 0.50 mm (.012" to .020")
■ Max. 0.46 mm x 0.56 mm (.018" x .022")



**45.9038.13**  
Stop pliers V-Bebd - 1mm

● 0.30 mm to 0.50 mm (.012" to .020")
■ Max. 0.43 mm x 0.56 mm (.017" x .028")



**45.9034.13**  
Cinch Back / tie back  
Distal end bending pliers

● 0.30 mm to 0.50 mm (.012" to .020")
■ Max. 0.56 mm x 0.71 mm (.022" x .028")



**45.9039.13**  
Lingual / palatal arch forming plies

● 0.76 mm (.030") / 0.91 mm (.036")
-------------------------------------



**45.9035.13**  
Hammer head  
Distal end bending pliers

● 0.30 mm to 0.50 mm (.012" to .020")
■ Max. 0.56 mm x 0.71 mm (.022" x .028")



**45.9040.13**  
Torquing pliers set



**45.9036.13**  
Nance  
Loop forming pliers

● 0.36 mm to 0.71 mm (.014" to .028")
■ Max. 0.56 mm x 0.71 mm (.022" x .028")



**45.9041.13**  
Tweed / angel  
Rectangular arch forming and  
torquing pliers

● 0.30 mm to 0.71 mm (.012" to .028")
■ Max. 0.56 mm x 0.71 mm (.022" x .028")



**45.9037.13**  
Detailing step pliers / Bayonet  
bending pliers - 1mm

● 0.30 mm to 0.50 mm (.012" to .020")
■ Max. 0.56 mm x 0.71 mm (.022" x .028")



**45.9042.13**  
Surgical ball hook crimping pliers,  
angled



**45.9043.13**  
Surgical ball hook crimping  
pliers, straight



- Щипцы для ортодонтии и протезирования
- Pincas pour l'orthodontie et la prothèse
- Zangen für Kieferorthopädie und Prothetik
- Щипці для ортодонції та протезування
- Alicates para ortodoncia y prótesis
- كماناتة لتقويم الأسنان بروستھتیس

## L-KEY JOINT PLIERS



**45.9044.13**  
Aderer Clamp three jaw wire bending plier for contouring and bending wire up to .30"/.76mm.



**45.9050.13**  
Falcon beak contouring plier.

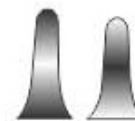

**45.9045.13**  
Bird beak plier for bending round, square and rectangle wire up to .30"/.76mm.

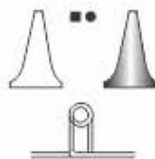

**45.9051.13**  
For placement and removal of arch wires, pins and other auxiliaries.



**45.9046.13**  
Bird beak plier for light wire bending round, square and rectangular up to .016"/0.41mm.

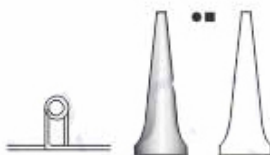

**45.9052.13**  
For placement and removal of arch wires, pins and other auxiliaries in angle design



**45.9047.13**  
Double Rounded jaw bending pliers, hooks and wire up to .020"/0.51mm.

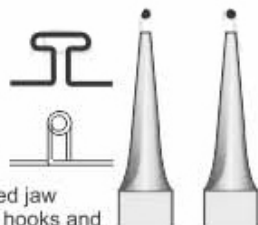

**45.9053.13**  
contouring Plier.



**45.9054.13**  
Bending plier. In order to skirt molares bands. With grooved. Recommended wire. 016", 018" and 022" 0.41mm, 0.46mm and 0.56mm



**45.9048.13**  
Adams pliers for hooks and bending wire up to .030"/0.76mm.

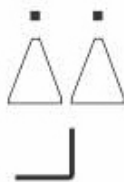

**45.9055.13**  
Loop forming in four length 3,4,5 & 6 mm wire capacity 0.22", 56mm.



**45.9049.13**  
Johnson pliers for crown band contouring



**45.9056.13**  
Arch bending plier design for convenient handling of square or rectangular wire, .020" / 0.51mm.



- Щипцы для ортодонтии и протезирования
- Pincers pour l'orthodontie et la prothèse
- Zangen für Kieferorthopädie und Prothetik
- Щипці для ортодонції та протезування
- Alicates para ortodoncia y prótesis
- كماناتة لتقويم الأسنان بروستیتیس

**LAP & L-KEY JOINT PLIERS**

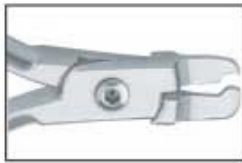

**45.9057.13**  
In order to skirt bands and crowns.



**45.9058.13**  
Wires up to .020" / 0.7mm.

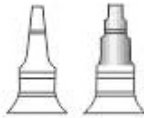

**45.9059.13**  
Round and concave plier for loop forming and banding wire up to .20" / .051mm.



**45.9060.13**  
Bending for round square or rectangular wire up to 0.30"/0.76mm



**45.9061.13**  
for double back and triple back bands in 0.30" / .76mm & 0.36" / .91mm lingual arch wires.



**45.9062.13**  
Detailing step plier double-sided offset beak permits bayonet bends. Creates right hand or left hand step-up or stepdown at 1/2, 3/4, or 1mm increments.



**45.9063.13**  
"V" bend stop special design makes 1mm "v" bends to shorten archwires or provide a positive stop. Excellent for placing stops in titanium wires. For round or rectangular wires up to .025"



**45.9064.13**  
Angle how plier efficient utility plier with serrated beaks for a firm grip. 45 angled tips to access hard to reach areas.



**45.9065.13**  
Weingardt plier serrated tips hold wires firmly at a convenient working angle. Tapered beaks fit easily between brackets and hard to reach areas. Our most popular utility plier.



**45.9066.13**  
Pin & Ligature Cutters TC.



**45.9067.13**  
Mini Pin & Ligature Cutter TC.



**45.9068.13**  
Standard Ligature Cutter TC.



**45.9069.13**  
V Bend Stop Plier TC.



**45.9070.13**  
Angled Direct Bond Bracket Remover TC.





45.9071.13

 Distal end Cutter, Safety Hold Plier  
(Ideal for Cutting Wire) TC.

45.9072.13

 Hook Crimping Plier Angled  
Straight TC.

45.9073.13

 3 Prong Clasp Adjustable  
Plier TC.

45.9074.13

Utility Plier Weingart TC.



45.9075.13

 Direct Bracket Remover  
TC.

45.9076.13

 Straight Direct Bond Bracket  
Remover TC.

45.9077.13

Pin Holding Plier TC.



45.9078.13

Hard wire cutters



45.9079.13

 Elastic Separating Plier  
Round Handle

45.9080.13

 Elastic  
Separating Plier

45.9081.13

 Smaha  
Elastomeric  
ligature  
placing forceps  
140 mm

45.9082.13

 Elastomeric  
ligature placing  
forceps with  
groove  
Falcon 140 mm

45.9083.13

 Elastomeric  
ligature placing  
forceps with  
groove  
Falcon 140 mm

# Dental Implants

A permanent solution  
for your missing tooth

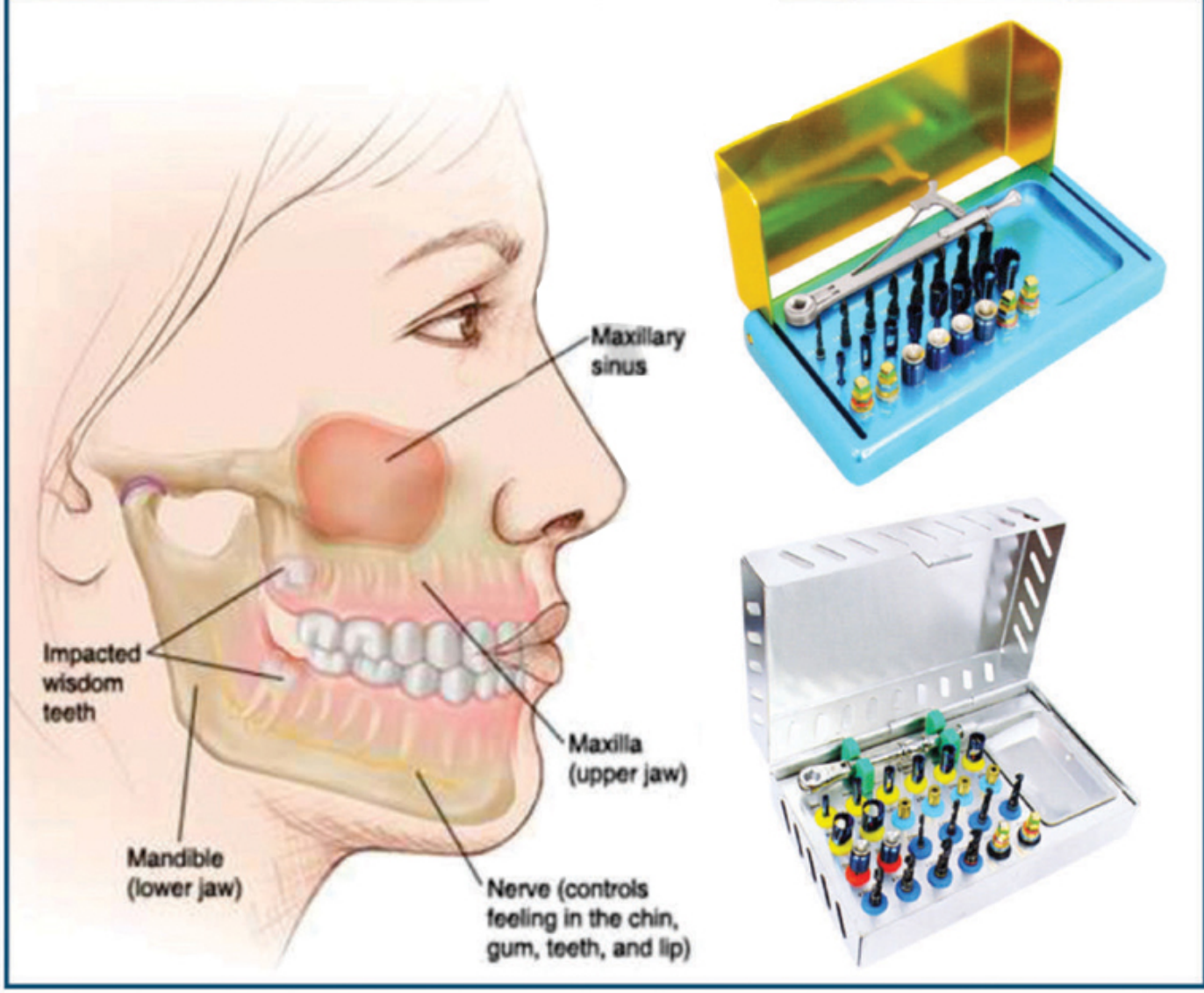

- Инструменты для имплантологии
- Implantologie
- Implantologie

- Інструменти для імплантології
- Implantoloia
- زراعة الأسنان

**IMPLANT GAGES**



**46.9101.01**  
**Multifunctional Meter**  
Length 90 mm,  
different sizes,  
8-10-11mm,  
corrosion-resistant

**46.9101.02**  
**Multifunctional Meter**  
Length 90 mm,  
different sizes,  
5-13-15-17 mm,  
corrosion-resistant

**46.9102.17**  
**Measuring Probe**  
Length 170 mm,  
hand shape or flexible  
(6-8-10-14-16 mm),  
corrosion-resistant

**46.9103.01**

**46.9103.02**

**46.9103.03**

**46.9103.04**

**IMPLANT GAGES**



**46.9104.01**

**46.9104.02**

**46.9104.03**

- Инструменты для имплантологии
- Implantologie
- Implantologie

- Инструменти для імплантології
- Implantologia
- زراعة الأسنان



**46.9105.15**  
Clamp, Osteometer  
Length about 155 mm,  
ridge width measurement,  
two-sided scale,  
measuring  
range 0 - 25 mm



**46.9106.01**  
Measuring Loop  
straight length 90 mm,  
measuring range  
0 - 40 mm,



**46.9106.02**  
Measuring Loop  
angled, length 90 mm,  
measuring range  
0 - 40 mm,



**46.9106.03**  
Measuring loop, Castroviejo  
angled, length 175 mm,  
measuring range 0 - 40 mm,  
with window



**46.9107.01**  
Boley Gauge  
Stainless Steel



**46.9108.01**  
Measuring Loop  
angled, length  
175 mm,  
measuring range  
0 - 40 mm,



**46.9108.02**  
Measuring Loop  
straight length  
175 mm,  
measuring range  
0 - 40 mm,



**46.9109.01**  
Fig. 1  
Iwanson  
spring caliper  
For metal and  
porcelain.



**46.9109.02**  
Fig. 2  
Iwanson  
spring caliper  
For wax.



**46.9110.40**  
Bone Thickness Gauge  
40mm, 180mm



**46.9111.90**  
Gauge  
for measuring  
distances  
(0 - 90 mm),

- Инструменты для имплантологии
  - Implantologie
  - Implantologie
- Інструменти для імплантології
  - Implantologia
  - زراعة الأسنان

BLACK TITANIUM COLOUR COATED INSTRUMENTS

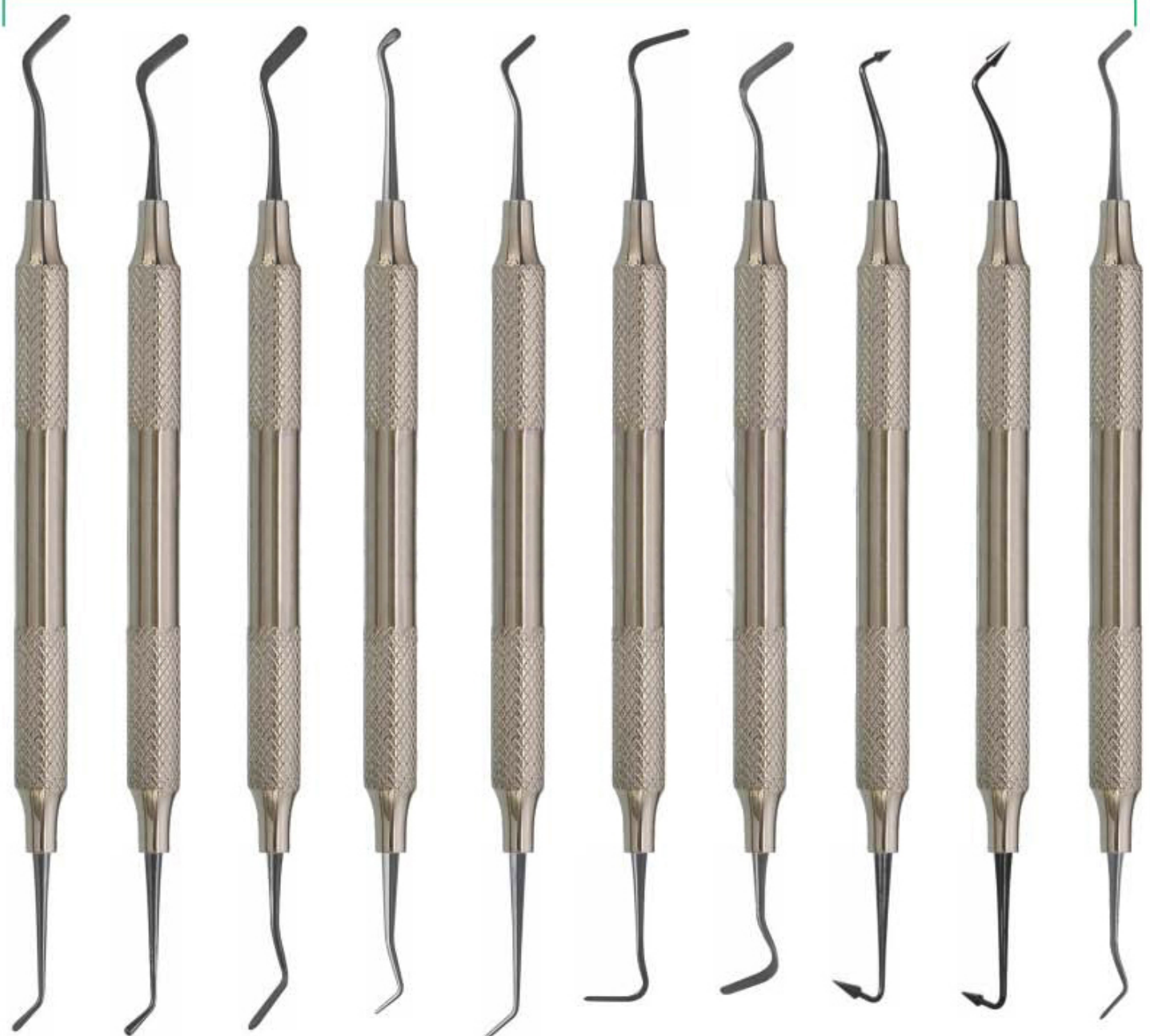

- |            |            |                  |            |            |                      |                  |                  |                  |                      |
|------------|------------|------------------|------------|------------|----------------------|------------------|------------------|------------------|----------------------|
| 46.9112.01 | 46.9112.02 | 46.9112.03       | 46.9114.01 | 46.9115.01 | 46.9116.01           | 46.9116.02       | 46.9117.01       | 46.9117.02       | 46.9118.03           |
| #1         | #2         | #3<br>Extra-Flex | Micro-Mini | Mini 1     | Mini 4<br>Extra-Flex | #4<br>Extra-Flex | #5<br>Flexi-Thin | #6<br>Flexi-Thin | Mini 3<br>Extra-Flex |

- Инструменты для имплантологии
  - Implantologie
  - Implantologie
- Инструменти для імплантології
  - Implantologia
  - زراعة الأسنان

## BLACK TITANIUM COLOUR COATED INSTRUMENTS

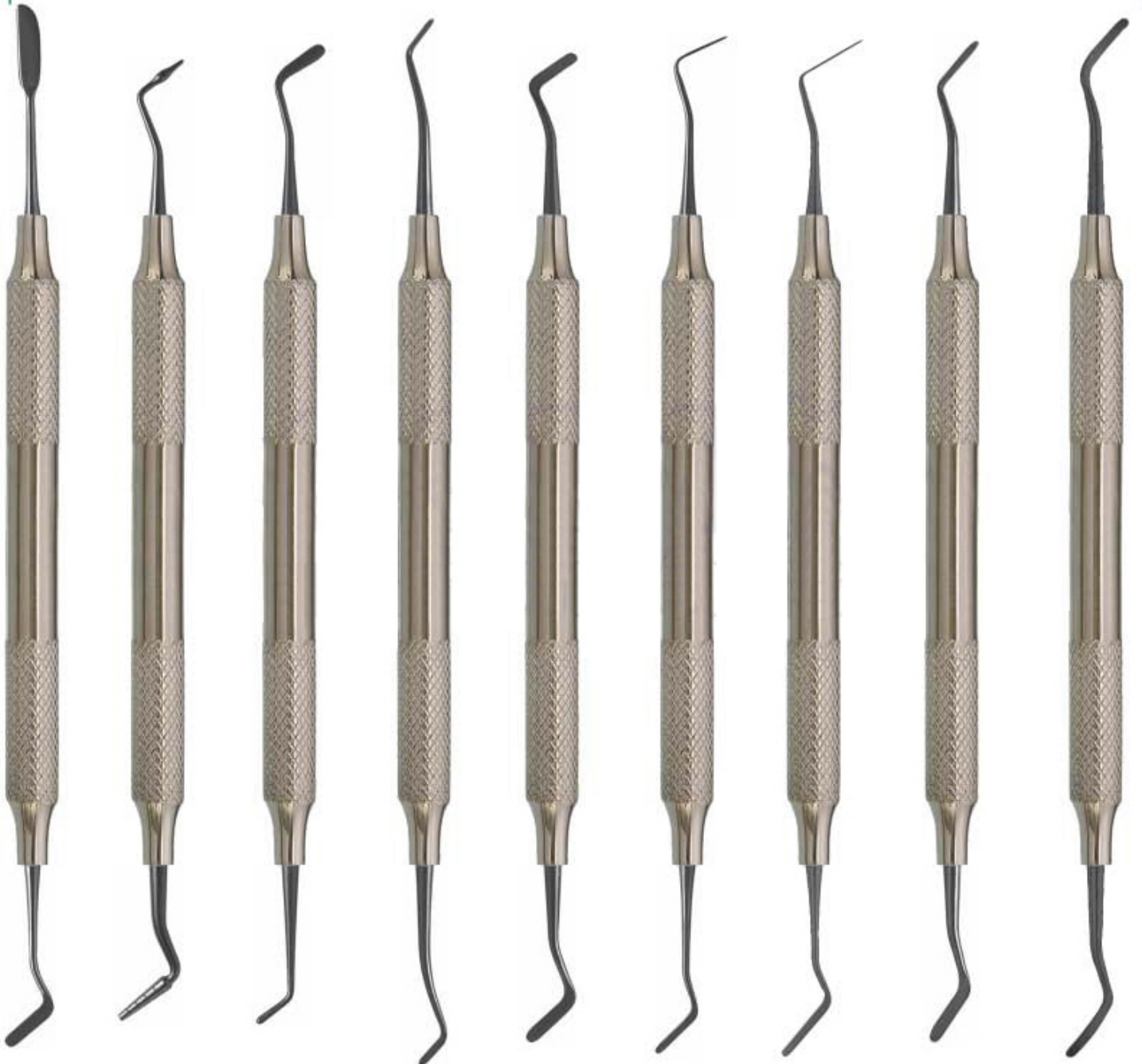

46.9119.01

AB1  
Boghosian

46.9119.02

AB2  
Boghosian

46.9120.03

W3

46.9121.01

8A

46.9122.04

4/5  
Gregg

46.9123.01

Interproximal  
Carver

46.9123.02

Interproximal  
Carver, Long

46.9124.06

A6

46.9125.01

Contouring  
instrument

- Инструменты для имплантологии
  - Implantologie
  - Implantologie
- Інструменти для імплантології
  - Implantologia
  - زراعة الأسنان

**BLACK TITANIUM COLOUR COATED INSTRUMENTS**

**BURNISHERS**

**FREEDMAN BURNISHERS**

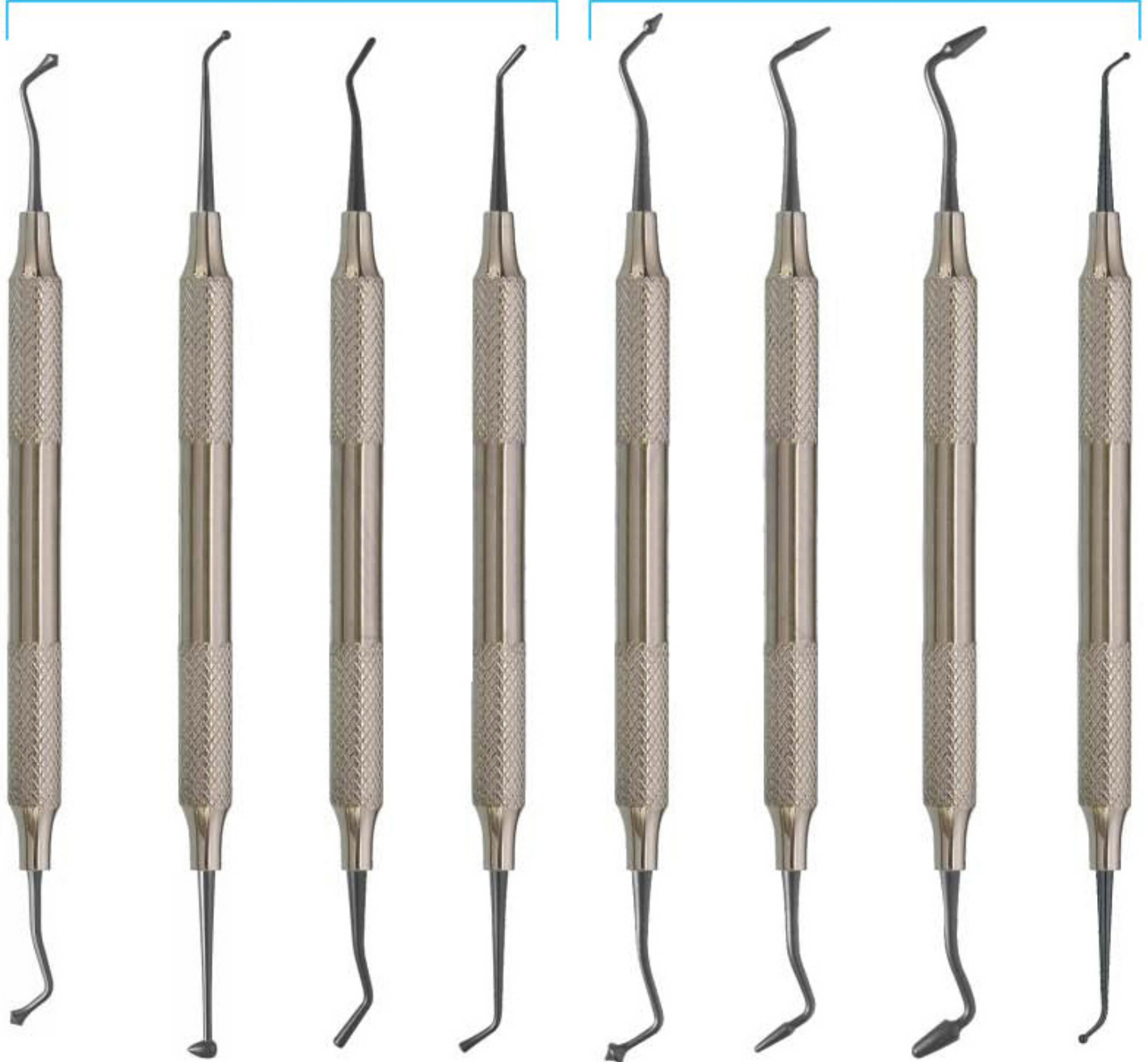

46.9126.21  
21B

46.9127.27  
27/29

46.9128.02  
2  
Ladmore

46.9128.03  
3  
Ladmore

46.9129.01  
Freedman  
"Duckhead"

46.9130.01  
Freedman  
Small Contact  
Forming

46.9130.02  
Freedman  
Large Contact  
Forming

46.9131.01  
Small/  
Medium Ball  
Burnisher

- Инструменты для имплантологии
- Implantologie
- Implantologie
- Инструменти для імплантології
- Implantoloia
- زراعة الأسنان

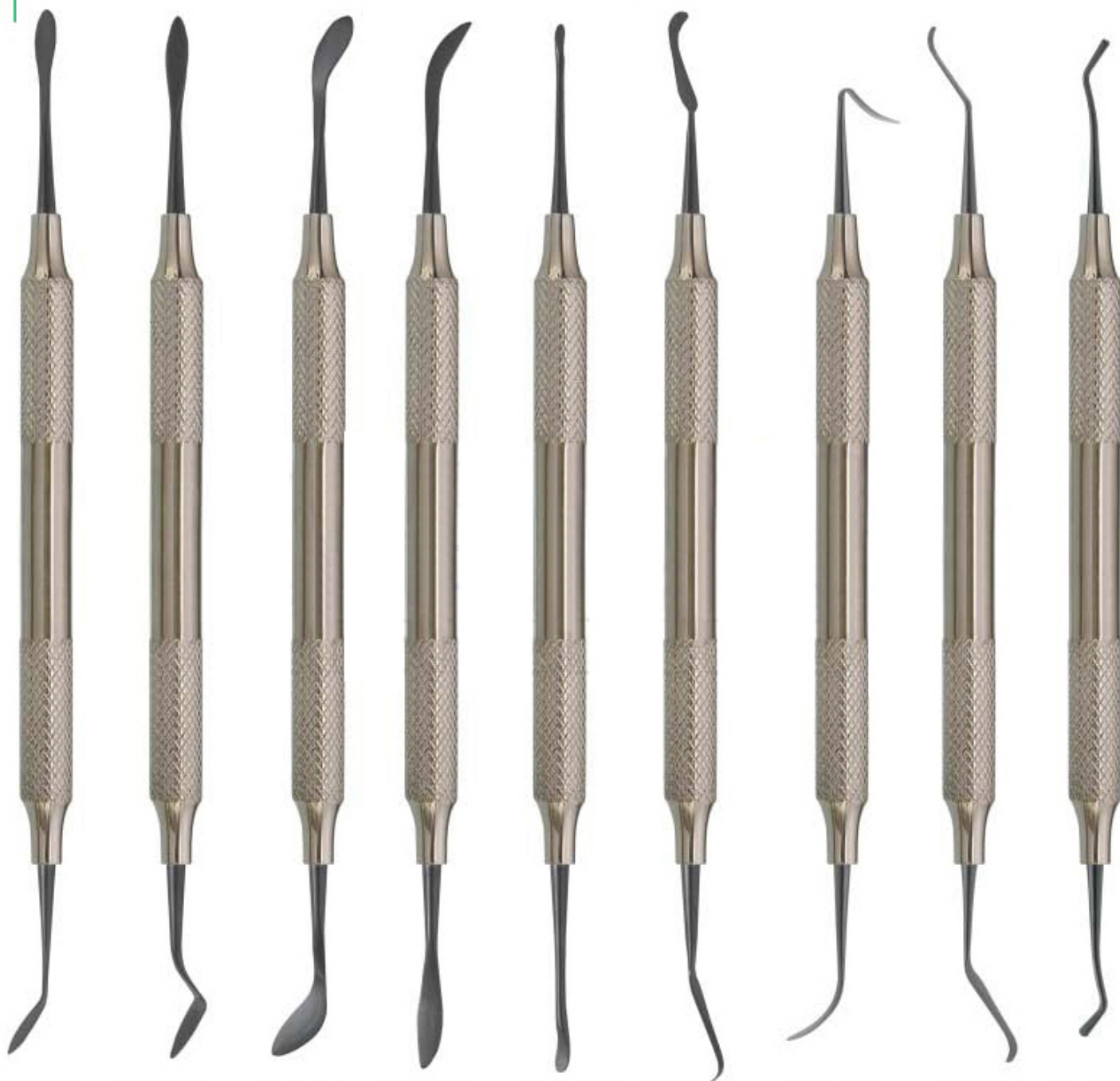
**BLACK TITANIUM COLOUR COATED INSTRUMENTS**

**46.9132.01**  
A  
Cosmetic  
Contouring

**46.9132.02**  
B  
Cosmetic  
Contouring

**46.9132.03**  
C  
Cosmetic  
Contouring

**46.9132.04**  
D  
Cosmetic  
Contouring

**46.9132.05**  
E  
Cosmetic  
Contouring

**46.9132.06**  
F  
Cosmetic  
Contouring

**46.9133.01**  
Marginal Ridge  
& Embrasure  
Shaping Instrument

**46.9134.01**  
Occlusal  
Anatomy  
Instrument

**46.9135.01**  
Composite  
Packing  
Instrument



- Инструменты для имплантологии
  - Implantologie
  - Implantologie
- Инструменти для имплантології
  - Implantologia
  - زراعة الأسنان

BLACK TITANIUM COLOUR COATED INSTRUMENTS

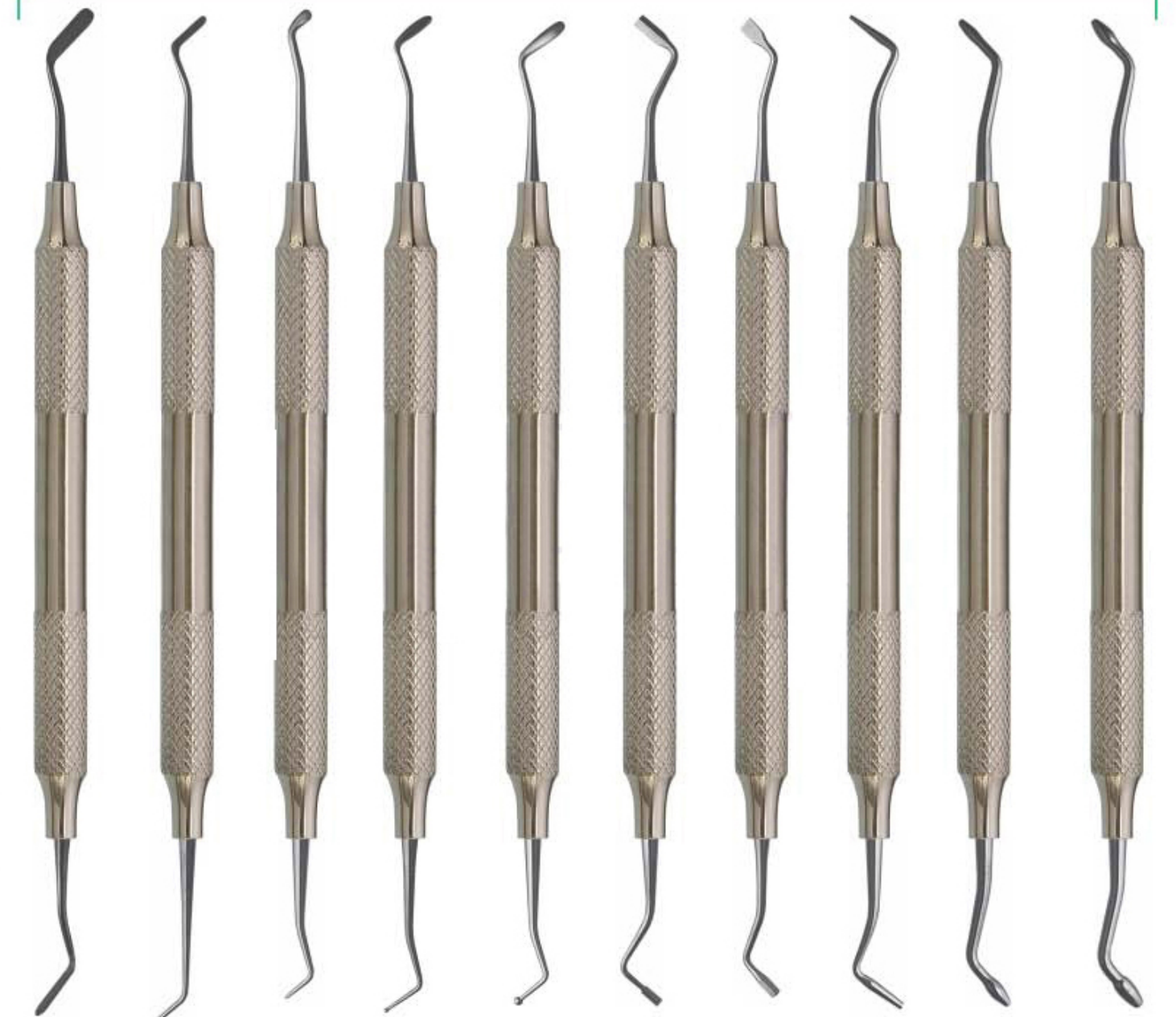

<b>46.9136.01</b> #3 Extra-Flex	<b>46.9137.01</b> Mini 1	<b>46.9138.01</b> Micro-Mini	<b>46.9139.01</b> Medium Placing/ Condensing	<b>46.9139.02</b> Large Placing/ Condensing	<b>46.9140.01</b> 0T Tanner	<b>46.9141.03</b> 3 Hollenback	<b>46.9142.05</b> 5A	<b>46.9143.01</b> Small/Medium Contact Forming	<b>46.9143.02</b> Medium/Large Contact Forming
---------------------------------------	-----------------------------	---------------------------------	---	--	-----------------------------------	--------------------------------------	-------------------------	---	---

- Инструменты для имплантологии
- Implantologie
- Implantologie
- Инструменти для імплантології
- Implantologia
- زراعة الأسنان

SINUS LIFT INSTRUMENTS HOLLOW HANDLE 9.5MM LENGTH 170MM

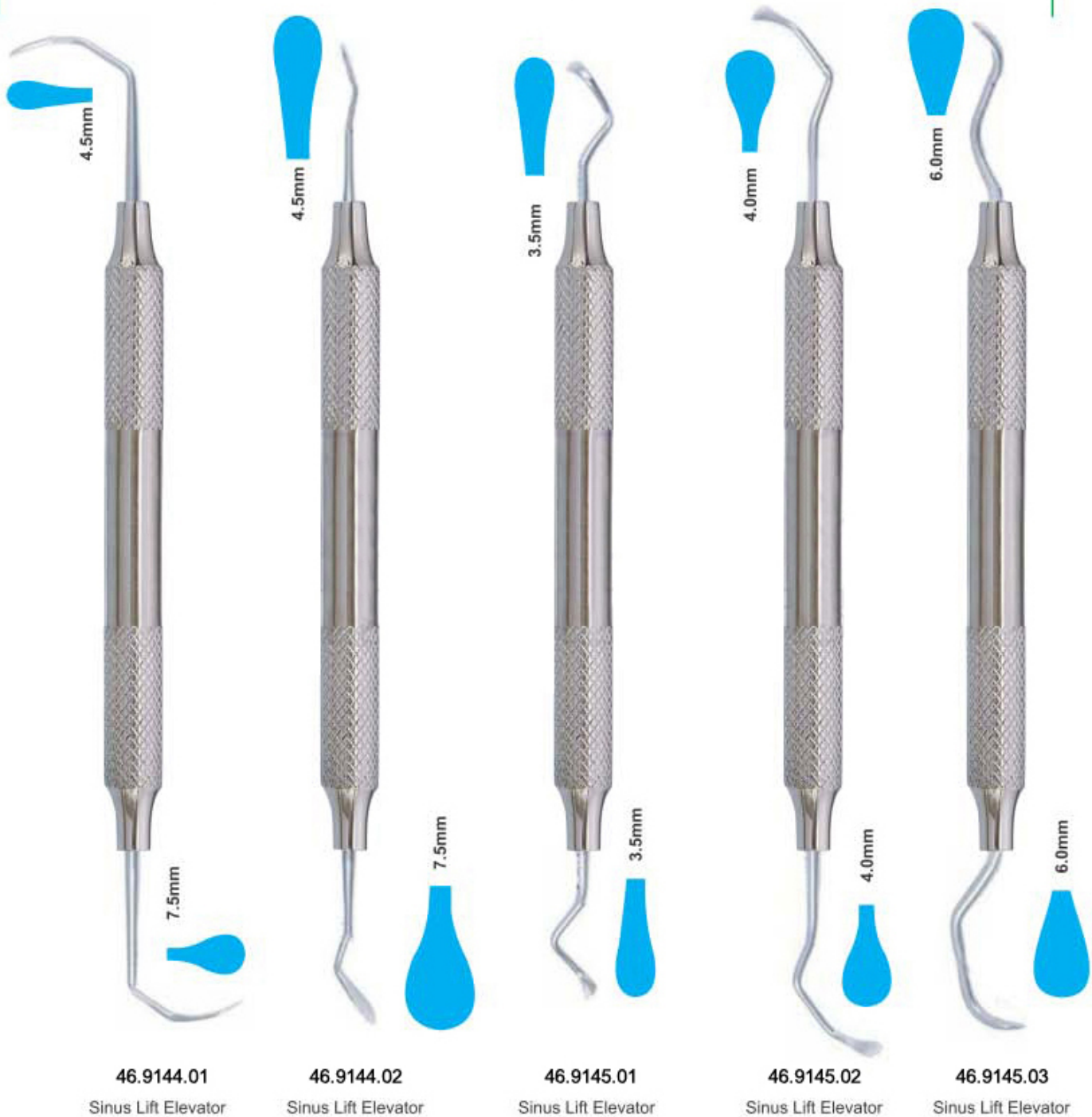

- Инструменты для имплантологии
  - Implantologie
  - Implantologie
- Інструменти для імплантології
  - Implantologia
  - زراعة الأسنان

**SINUS LIFT INSTRUMENTS HOLLOW HANDLE 9.5MM LENGTH 170MM**



**46.9146.01**  
Sinus Lift Elevator



**46.9146.02**  
Sinus Lift Elevator



**46.9146.03**  
Sinus Lift Elevator



**46.9146.04**  
Sinus Lift Elevator

- Инструменты для имплантологии
- Implantologie
- Implantologie
- Инструменти для імплантології
- Implantologia
- زراعة الأسنان

IMPLANT SINUS LIFT INSTRUMENTS HOLLOW HANDLE 9.5MM LENGTH 170MM

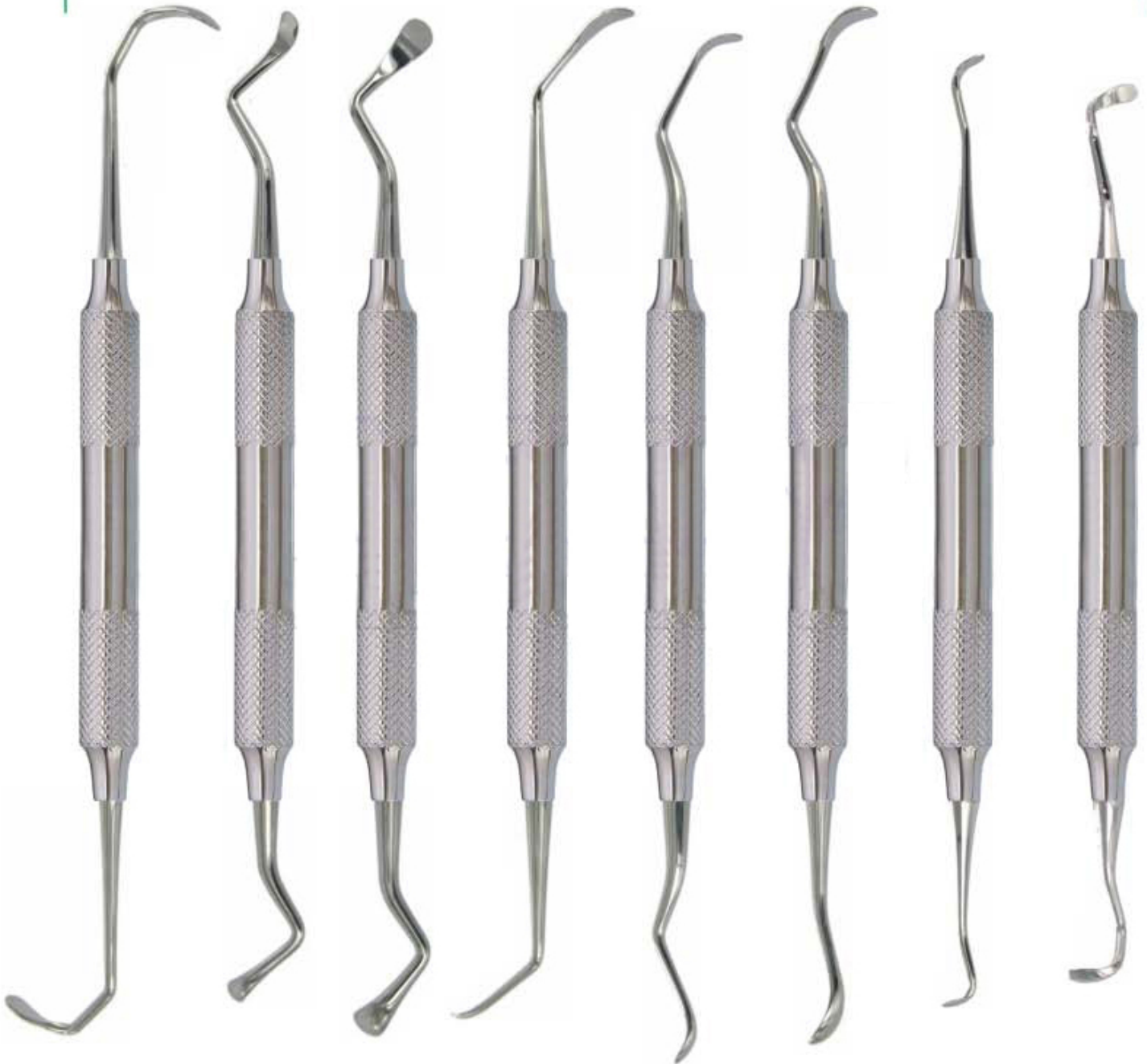

46.9147.65  
Acute 6577

46.9148.01  
Sinus1

46.9148.02  
Sinus2

46.9149.03  
Sinus3,  
Obtuse 6578

46.9149.04  
Sinus4

46.9149.05  
Sinus5

46.9149.06  
Sinus6

46.9149.07  
Sinus7

- Инструменты для имплантологии
  - Implantologie
  - Implantologie
- Инструменти для імплантології
  - Implantoloia
  - زراعة الأسنان

**SINUS LIFT INSTRUMENTS HOLLOW HANDLE 9.5MM LENGTH 170MM**

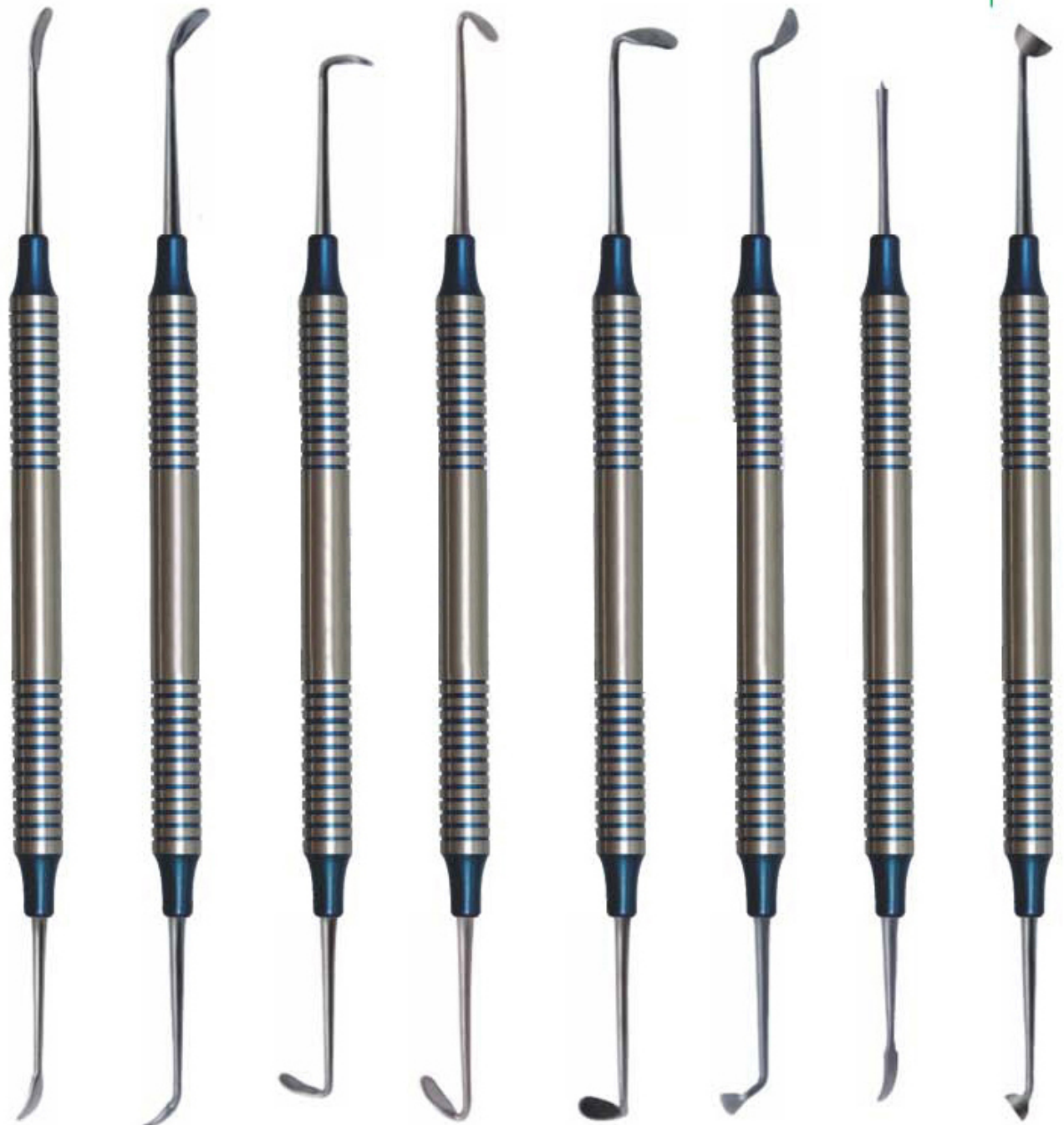

<b>46.9150.01</b> Sinuslift 1	<b>46.9150.02</b> Sinuslift 2	<b>46.9150.03</b> Sinuslift 3	<b>46.9150.04</b> Sinuslift 4	<b>46.9150.05</b> Sinuslift 5	<b>46.9150.06</b> Sinuslift 6	<b>46.9151.01</b> Membrane 3Positioning 1	<b>46.9151.01</b> Condenser 1
----------------------------------	----------------------------------	----------------------------------	----------------------------------	----------------------------------	----------------------------------	---	----------------------------------

- Инструменты для имплантологии
- Implantologie
- Implantologie

- Инструменти для імплантології
- Implantologia
- زراعة الأسنان

**Sinus Lift Instrument,**  
Flexible Sinus Lift instruments  
reduce the risk of perforation of the  
"Schneider's membrane"



46.9152.01

Fig. 1

46.9152.02

Fig. 2

46.9152.03

Fig. 3

**Sinus Lift Elevator,**  
10 mm Straight grip  
Length 175 mm, Sinus lift elevators, dull,  
for gentle peeling and lifting the  
Schneider membrane



46.9153.01

Fig. 1

46.9153.02

Fig. 2

46.9153.03

Fig. 3

**Sinus lift instrument**  
10 mm Straight grip Length 180 mm,  
Buser (B1, B2, B3) raspatories,  
quality medical stainless steel,  
corrosion-resistant



46.9154.01

B01

46.9154.02

B02

46.9154.03

B03

- Инструменты для имплантологии
  - Implantologie
  - Implantologie
- Инструменти для імплантології
  - Implantologia
  - زراعة الأسنان

Sinus lift instrument 10 mm Straight grip Sinus lift elevators, blunt or sharply curved (H01, H02, K03, K04, K78, K77)

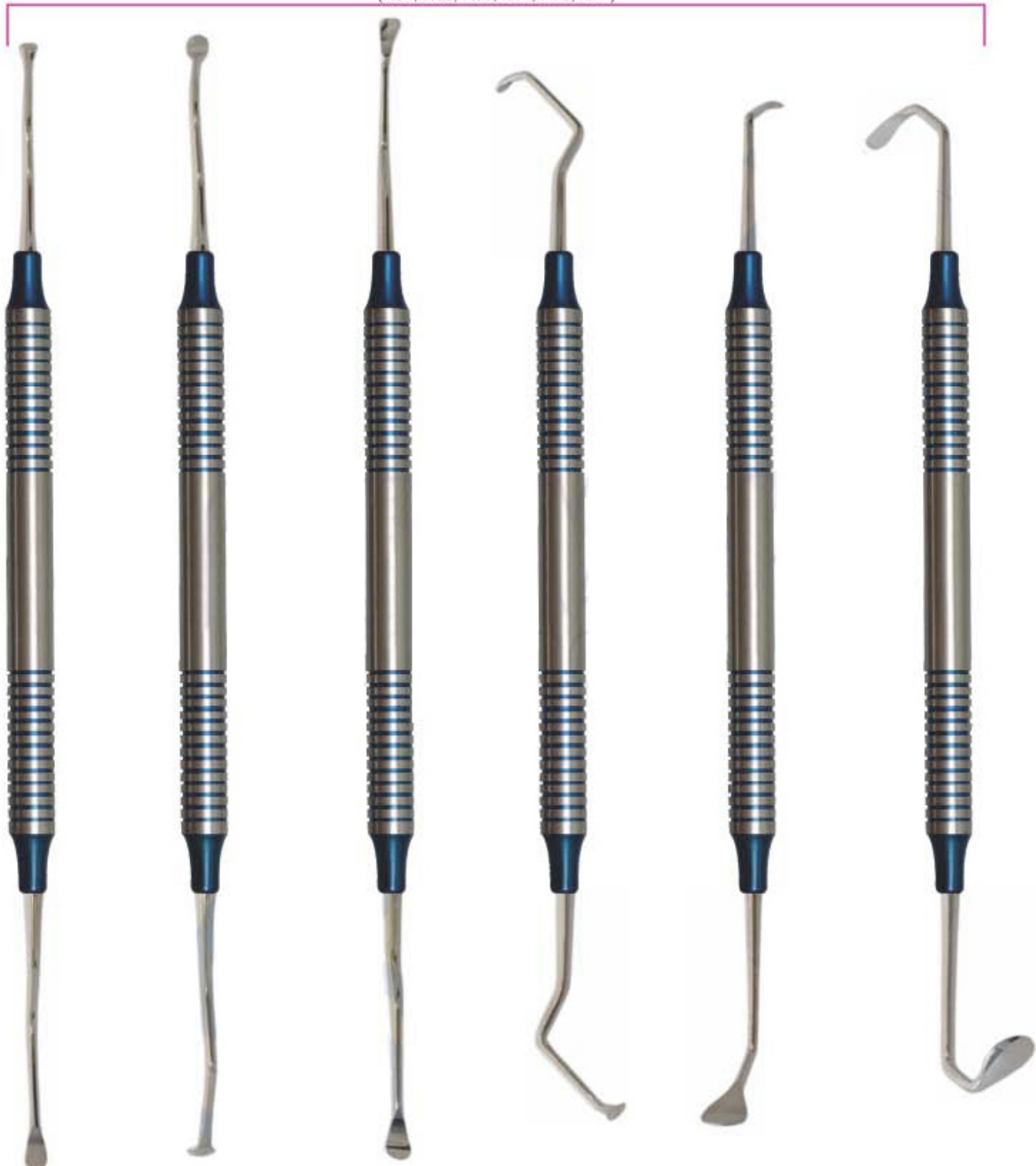

**46.9155.01**  
Sinus lift instrument H01

**46.9155.02**  
Sinus lift instrument H02

**46.9156.01**  
Sinus lift instrument K03

**46.9156.02**  
Sinus lift instrument K04

**46.9156.03**  
Sinus lift instrument K78

**46.9156.04**  
Sinus lift instrument K77

- Инструменты для имплантологии
- Implantologie
- Implantologie
- Инструменти для імплантології
- Implantologia
- زراعة الأسنان

### SINUS LIFT INSTRUMENT

Sinus Lift Elevators, 10 mm Hollow Handle length 170mm Blunt Curved Set of 6 Pcs

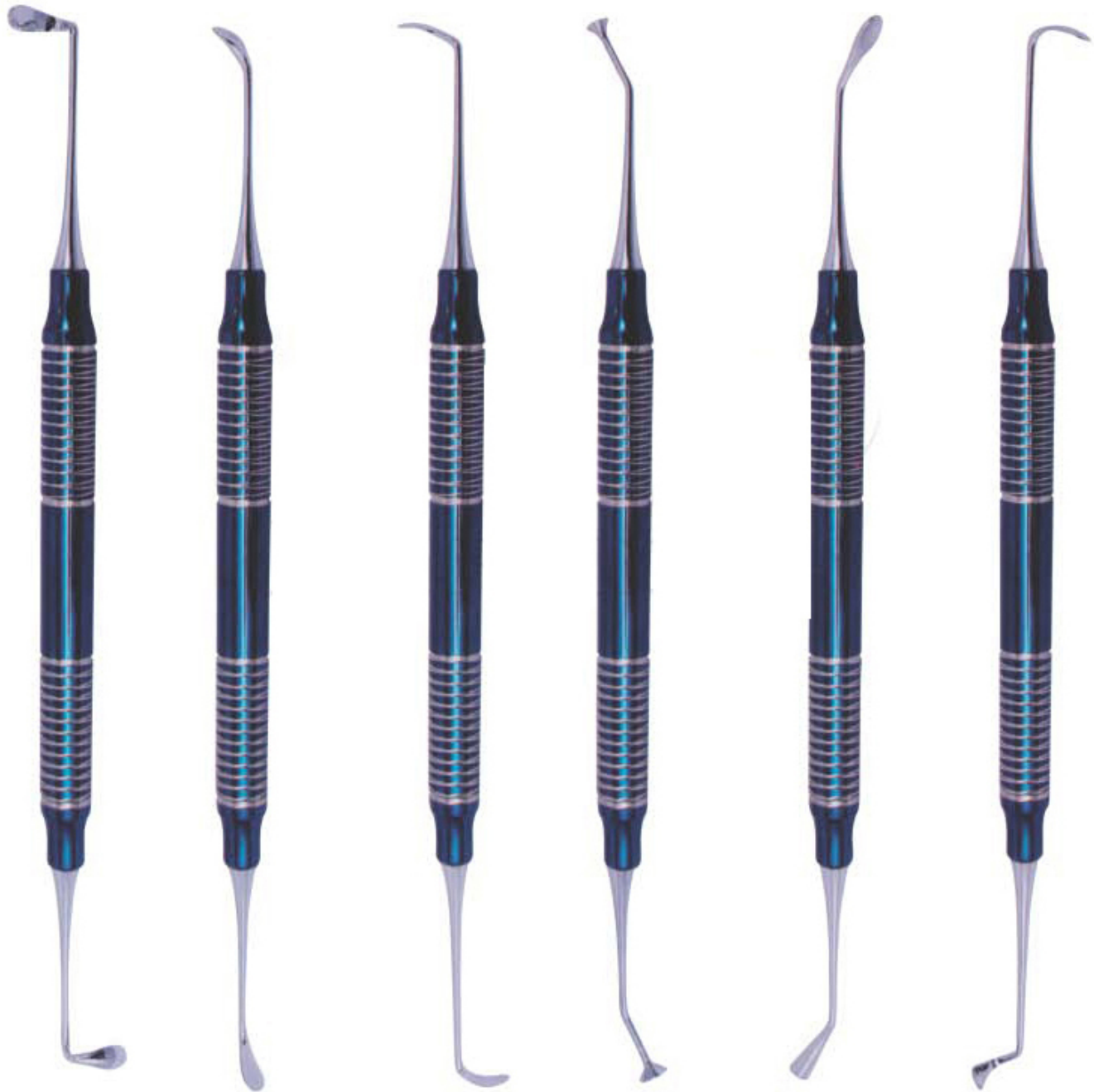

46.9157.01

46.9157.02

46.9157.03

46.9157.04

46.9157.05

46.9157.06



- Инструменты для имплантологии
- Implantologie
- Implantologia

- Инструменти для імплантології
- Implantologia
- زراعة الأسنان

IMPLANT SINUS LIFT INSTRUMENTS  
PERIODONTAL SURGERY    SURGICAL CHISELS  
KRAMER NEVINS SINUS LIFT



46.9158.01 TG



46.9159.03 SOLT3/4



46.9160.01 TGO



46.9161.29 29K



46.9162.14 FEDI4



46.9163.03 OCH3



46.9163.04 OCH4



46.9164.11 FEDI1



46.9164.12 FEDI2



46.9164.13 FEDI3



46.9165.36 Gf36

- Инструменты для имплантологии
- Implantologie
- Implantologie

- Инструменти для імплантології
- Implantologia
- زراعة الأسنان

## IMPLANT

## SURGICAL CHISELS

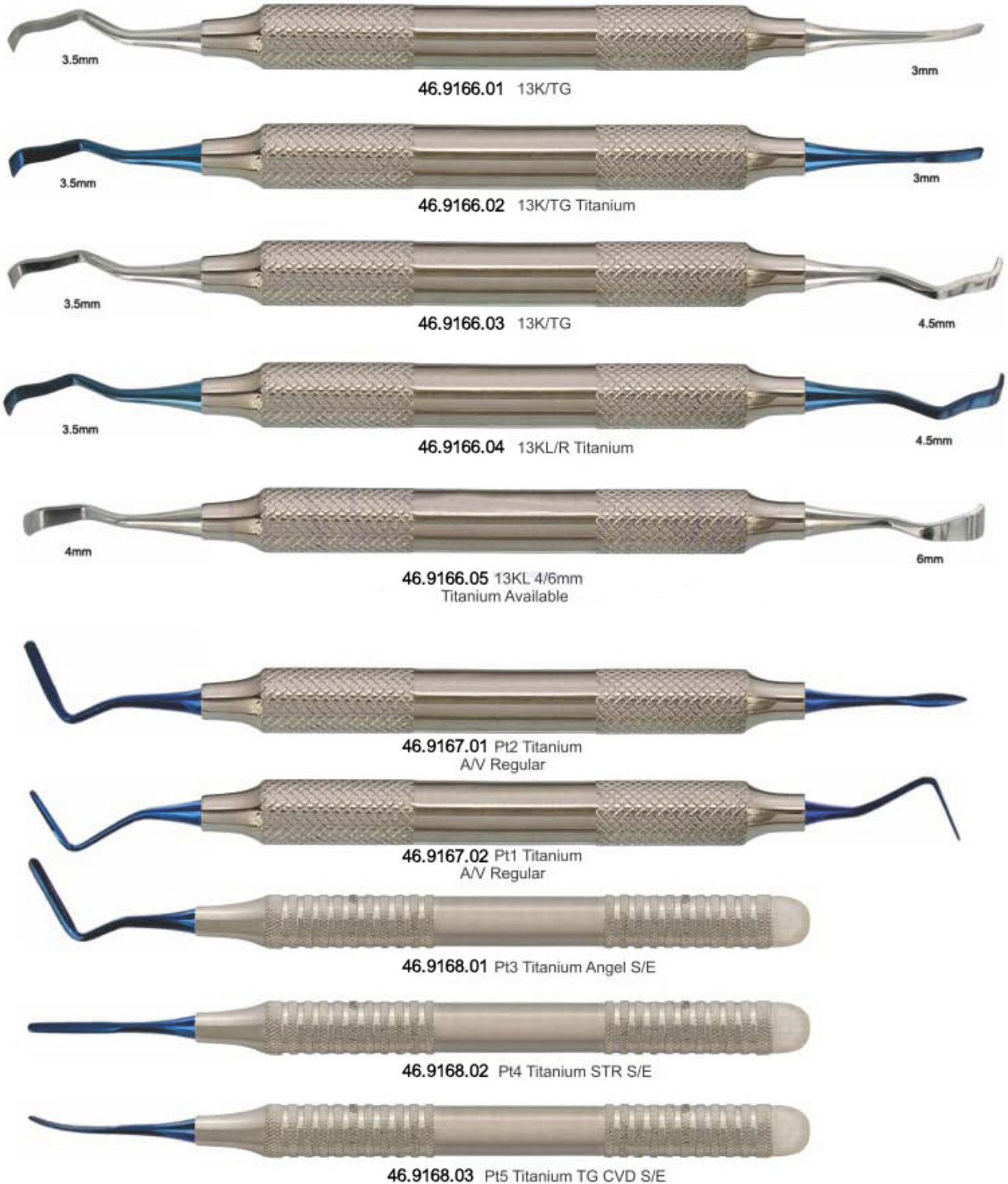

- Инструменты для имплантологии
- Implantologie
- Implantologie
- Инструменти для імплантології
- Implantologia
- زراعة الأسنان

**MIXING SPATULA WITH SHOVEL**



**46.9169.01**  
Bone Carrier  
Titanium



**46.9170.01**  
Raspator, Prichard  
Length 180 mm,  
10 mm hollow handle,  
double-ended  
10.5 mm | 4.5 mm,



**46.9170.02**  
Raspator, Prichard  
Length 180 mm,  
10 mm hollow handle,  
double ended



**46.9170.03**  
Raspator, Prichard  
Length 180 mm,  
10 mm hollow handle,  
double-ended  
10.5 mm | 4.5 mm,



**46.9171.01**  
Mixing Spatula  
with shovel  
17cm



**46.9171.02**  
Mixing Spatula  
with shovel  
18.5cm

- Инструменты для имплантологии
- Implantologie
- Implantologie
- Инструменти для імплантології
- Implantologia
- زراعة الأسنان

### BONE GRAFTING INSTRUMENTS COMPACTOR /TAMPERS

Product offering includes instruments for harvesting, mixing and compacting bone Provides clinicians with the proper instrumentation for bone grafting procedures Weighted bone basin Prevents tipping and spilling of bone and other materials during mixing



**46.9172.04**  
Graft Packer,  
Concave Tips  
DE 4/6mm

**46.9173.03**  
Bone Spoon/  
Packer DE 3mm

**46.9174.01**  
Graft Packer,  
Serrated Tips  
DE 6/8mm

**46.9174.02**  
Graft Packer,  
Serrated Tips  
DE 3/4mm

**46.9174.03**  
Graft Packer,  
Smooth Tips  
DE 5/8mm

**46.9175.01**  
Titanium graft packer/  
placement site depth  
gauge 3.3mm & 4.0mm  
Diameter tips Marked  
at 8, 11, 13, 15 & 18mm

**46.9176.01**  
Graft Material Spoon  
Concave Tip For  
Larger Grafts

- Инструменты для имплантологии
- Implantologie
- Implantologie
- Инструменти для імплантології
- Implantologia
- زراعة الأسنان

**BONE GRAFTING INSTRUMENTS**



**46.9177.01**  
**Blade and pusher**  
Length 180 mm,  
for straight or angled,  
blade: 15 x 5 mm,  
pusher: 4 mm diameter  
Straight



**46.9177.02**  
**Blade and pusher**  
Length 180 mm,  
for straight or angled,  
blade: 15 x 5 mm,  
pusher: 4 mm diameter  
angular



**46.9177.03**  
**Spoon and pusher**  
Length 180 mm,  
for angled spoon:  
10 x 5 mm, pusher:  
diameter 3 mm



**46.9178.01**  
**Tunnelierungs Instrument**  
length 175 mm,



**46.9178.02**  
**Tunnelierungs Instrument**  
length 175 mm,  
different designs



**46.9179.17**  
**Tamper**  
Length 170 mm,  
for bone material,  
double-ended,  
diameter 3.2 mm  
(2-4-6-8-10) and diameter  
2.5mm (2-4-6-8-10)

- Инструменты для имплантологии
- Implantologie
- Implantologie
- Інструменти для імплантології
- Implantologia
- زراعة الأسنان

### Pluggers Clarizio

Length 160 mm, with titanium tips for mixing and pouring of autologous, heterologous bone substitute material, diameter (3/4 or 6/8 mm)

### BONE GRAFTING INSTRUMENTS



46.9180.04 Ø 4mm  
46.9180.05 Ø 5mm  
Compactor  
150mm



46.9181.01  
Sinus Window  
Bone Tampers  
4 mm



46.9181.02  
Sinus Window  
Bone Tampers  
7 mm



46.9182.01  
6/8mm



46.9182.02  
3/4mm

- Инструменты для имплантологии
- Инструменти для имплантології
- Implantologie
- Implantoloia
- Implantologie
- زراعة الأسنان

**SPOON AND PUSHER (TRINOVO)**

Trinovo handle, different workers, for bone material, high-grade medical stainless steel, corrosion-resistant

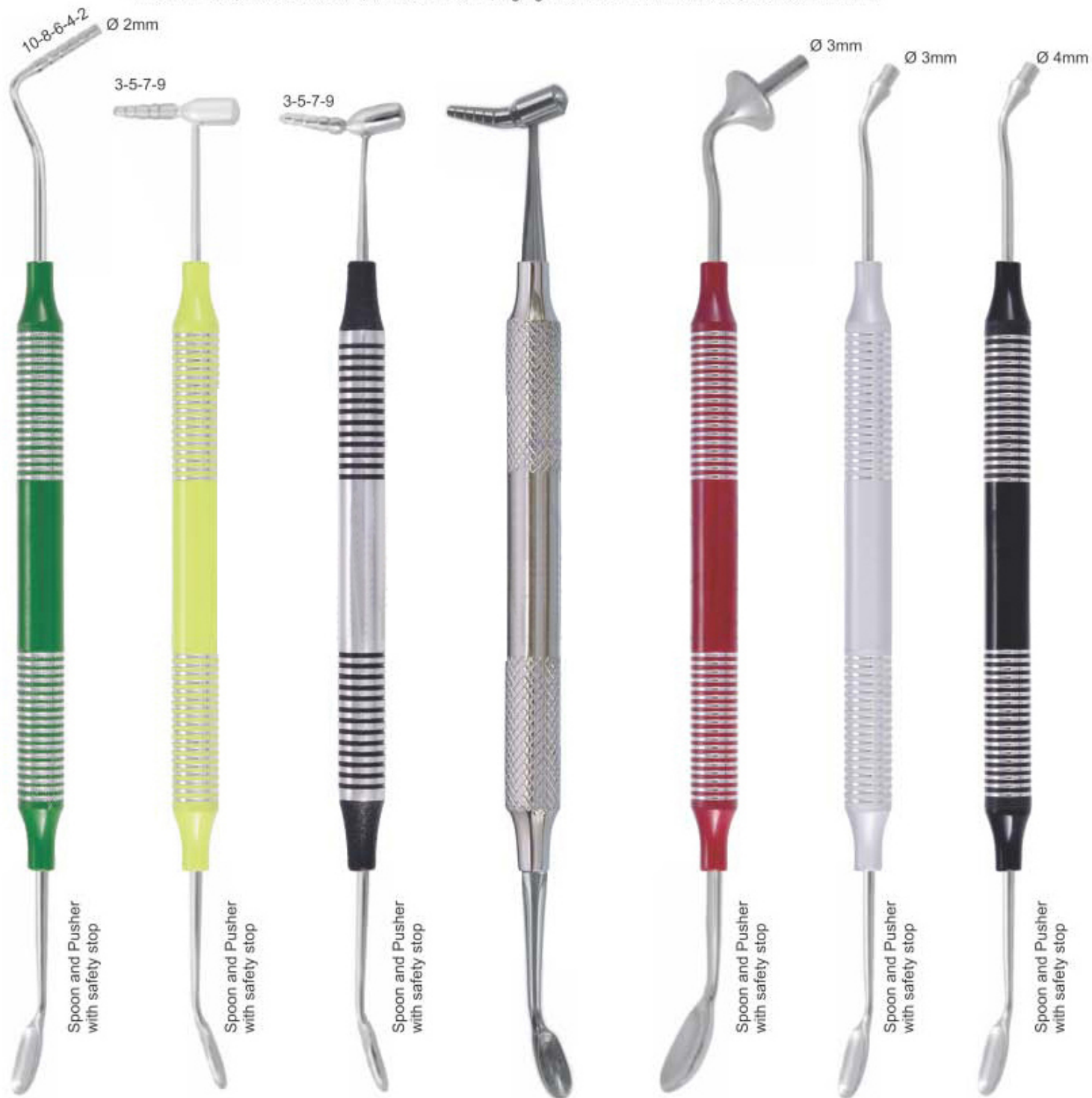

**46.9183.01**  
10x5mm

**46.9183.02**  
10x5mm

**46.9183.03**  
10x5mm

**46.9184.01**  
Bone Graft/Carrier  
Titanium  
2-4-6-8-10mm

**46.9185.01**  
15x10mm

**46.9185.02**  
10x5mm

**46.9185.03**  
10x5mm

- Инструменты для имплантологии
- Implantologie
- Implantologie
- Інструменти для імплантології
- Implantologia
- زراعة الأسنان

### PERIOSTEALS ELEVATOR 10mm Hollow Handle



**46.9186.01**  
Raspator,  
BonexScraper  
Length 165 mm,  
10 mm hollow  
handle,  
double-ended 6  
mm / 4 mm,

**46.9186.02**  
Raspator,  
Raspatory  
Length 180 mm,  
10 mm hollow  
handle,  
double-ended  
3 mm | 3 mm,

**46.9186.03**  
Raspator,  
Raspatory  
Length 180 mm,  
10 mm hollow  
handle,  
double-ended  
3 mm | 3 mm,

**46.9187.18**  
Raspator,  
Papilla  
Length 185 mm,  
10 mm hollow  
handle,  
double-ended  
3 mm | 2 mm,

**46.9188.01**  
Raspator,  
bone scraper  
Length 175 mm,  
10 mm hollow  
handle,  
double-ended,

**46.9188.02**  
Raspator,  
micro-Freer  
Length 180 mm,  
6 mm solid grip,  
double-ended  
3 mm | 4 mm

**46.9188.03**  
Raspator,  
Freer  
Length 180 mm,  
6 mm solid  
handle,  
double-ended  
5 mm | 5 mm,



- Инструменты для имплантологии
  - Implantologie
  - Implantologie
- Інструменти для імплантології
  - Implantoloia
  - زراعة الأسنان

**PERIOSTEALS ELEVATOR 10mm Hollow Handle**



**46.9189.01**  
Raspator,  
Freer  
10 mm hollow  
handle,  
high-quality  
medical  
double ended



**46.9189.02**  
Raspator,  
Molt  
Length 180 mm,  
8 mm solid  
grip,  
double-ended  
6 mm



**46.9190.01**  
Raspator,  
micro Freer  
Length 185 mm,  
10 mm hollow  
handle,  
double-ended,



**46.9190.02**  
Raspator,  
micro Freer  
Length 185 mm,  
10 mm hollow  
handle,  
double-ended,



**46.9191.01**  
Raspator, micro  
Raspator /  
chisel  
Length 170 mm,  
10 mm hollow  
handle,  
double-ended,



**46.9191.02**  
Raspator, micro  
Raspator /  
chisel  
Length 175 mm,  
10 mm hollow  
handle,  
double-ended,



**46.9191.03**  
Raspator,  
Micro Raspator /  
chisel  
Length 175 mm,  
8 mm solid handle,  
double-ended  
3.5mm | 3.5 mm,

- Инструменты для имплантологии
- Implantologie
- Implantologie
- Инструменти для імплантології
- Implantologia
- زراعة الأسنان

### PERIOSTEALS ELEVATOR 10mm Hollow Handle



**46.9192.017**  
Raspatory Micro Molt  
Length 175 mm,  
corrosion-resistant

**46.9193.24**  
Raspatory Chipping  
Workers:  
Chisel 24G and 7.5 mm,  
length about 175 mm,  
corrosion-resistant

**46.9194.05**  
Raspatory MOLT  
Work ends:  
5.0 mm and 4.0 mm,  
length about 175 mm,  
corrosion-resistant

**46.9196.17**  
Rasp, Molt M9  
Length 175 mm,  
corrosion-resistant

**46.9197.17**  
Raspator, WAUTIER  
Length 175 mm,  
corrosion-resistant

**46.9198.17**  
Raspator, BENQUE  
Length 170 mm,  
workers  
5 mm | 7 mm,  
corrosion-resistant

**46.9199.18**  
Raspator, Nordberg  
Length 180 mm,  
8 mm hollow handle,  
double-ended  
6 mm | 4 mm

- Инструменты для имплантологии
  - Implantologie
  - Implantologie
- Инструменти для имплантології
  - Implantoloia
  - زراعة الأسنان

**Hollow Handle 10mm Length 170mm**

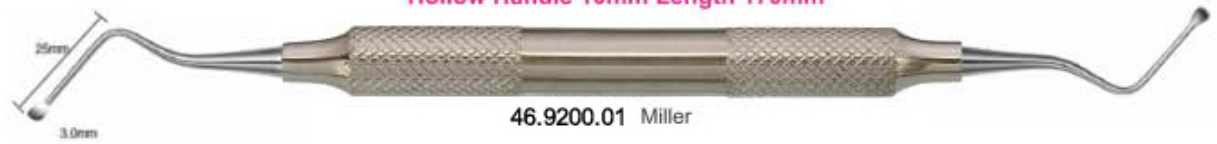

46.9200.01 Miller



46.9200.02 Miller



46.9201.01 LUCAS #84



46.9201.02 LUCAS #85



46.9201.03 LUCAS #86



46.9201.04 LUCAS #87



46.9201.05 LUCAS #88



46.9202.01 LUCAS86S  
SERRATED



46.9202.02 LUCAS86AS  
SERRATED

- Инструменты для имплантологии
- Implantologie
- Implantologie
- Инструменти для імплантології
- Implantologia
- زراعة الأسنان

**TISSUE MEMBRANE FORCEPS**

**46.9203.01**  
Tissue Graft Forcep  
Serrated Teeth



**46.9204.01**  
Self Locking  
Grooved



**46.9205.01**  
Tissue Graft Forcep  
Serrated Teeth



**46.9206.01**  
Titanium  
Locking Plier



**46.9207.14**  
TC Gripper Carbide  
Tipped Tissue Forceps  
Serrated Carbide Tips  
14.5cm



**46.9208.12**  
Adson Carbide  
Tipped Tissue Forceps  
Serrated Carbide Tips  
12cm



**46.9209.01**  
Micor Adson 1x2  
Tissue Forcep 12.1cm  
1x2 Teeth - 0.5mm Tips



**46.9210.01**  
Adson 7x7  
Tissue Forceps  
7x7 Teeth 12cm



**46.9210.02**  
Adson 7x7 Curved  
Tissue Forceps  
7x7 Teeth 12cm



**46.9211.16**  
Suture Pliers  
Suture Forceps with  
1.6mm Ring Tip



**46.9212.01**  
Debakey Atraumatic  
Tissue Forceps Straight  
Serrated Teeth  
16cm



**46.9212.02**  
Debakey Atraumatic  
Tissue Forceps Curved  
Serrated Teeth  
16cm



- Инструменты для имплантологии
- Implantologie
- Implantologie

- Инструменти для имплантології
- Implantologia
- زراعة الأسنان

**TISSUE MEMBRANE FORCEPS**



**46.9213.01**  
Russian Long  
Tissue Forceps  
Serrated Tip  
20cm



**46.9213.02**  
Russian  
Tissue Forceps  
Serrated Tip  
15cm



**46.9214.01**  
Tissue Punch Forceps  
To Remove Tissue  
After Using Punch



**46.9215.01**  
13.5 cm  
narrow



**46.9215.02**  
10.5 cm  
**Membrane tweezers KUEHNE**



**46.9215.03**  
13.5 cm  
wide



**46.9216.15**  
**Pin-Tweezers**  
with or without lock,  
length 15 cm,  
with lock



**46.9217.01**  
without lock,  
length 15 cm



**46.9218.15**  
**Haltepinzette with lock**  
15,5 cm, for pins, towards  
the tips, etc.,



**46.9219.01**  
Carry Forceps  
15cm



**46.9219.02**  
Carry Forceps  
15cm



**46.9219.03**  
Carry Forceps  
15cm

- Инструменты для имплантологии
  - Implantologie
  - Implantologie
- Инструменти для імплантології
  - Implantologia
  - زراعة الأسنان

OSTEOTOME CONVEXES / CONCAVE / CONIQUES

CONVEXES



46.9220.01  
SET OF 5 PIECES

CONCAVES



46.9220.02  
SET OF 5 PIECES

CONIQUES



46.9220.03  
SET OF 5 PIECES

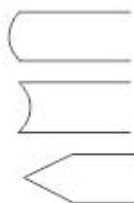
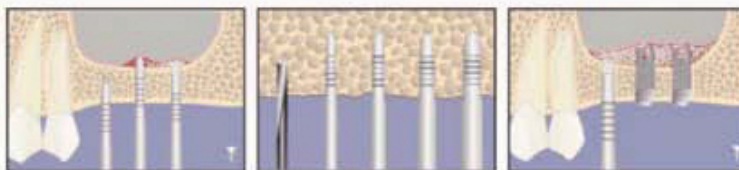

CONVEXES STRAIGHT	46.9220.01	2,7 Ømm	3,2 Ømm	3,7 Ømm	4,2 Ømm	5 Ømm
CONCAVES STRAIGHT	46.9220.02	2,7 Ømm	3,2 Ømm	3,7 Ømm	4,2 Ømm	5 Ømm
CONIQUES STRAIGHT	46.9220.03	2,7 Ømm	3,2 Ømm	3,7 Ømm	4,2 Ømm	5 Ømm

- Инструменты для имплантологии
- Implantologie
- Implantologie

- Инструменти для імплантології
- Implantologia
- زراعة الأسنان

**OSTEOTOME CONVEXES / CONCAVE / CONIQUES**

CONVEXES



**46.9221.01**  
SET OF 5 PIECES

CONCAVES



**46.9221.02**  
SET OF 5 PIECES

CONIQUES



**46.9221.03**  
SET OF 5 PIECES

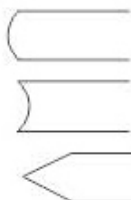
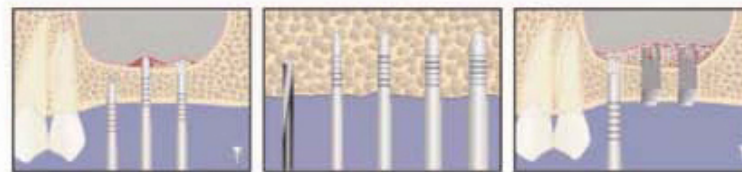

CONVEXES CURVED	<b>46.9221.01</b>	2,7 Ømm	3,2 Ømm	3,7 Ømm	4,2 Ømm	5 Ømm
CONCAVES CURVED	<b>46.9221.02</b>	2,7 Ømm	3,2 Ømm	3,7 Ømm	4,2 Ømm	5 Ømm
CONIQUES CURVED	<b>46.9221.03</b>	2,7 Ømm	3,2 Ømm	3,7 Ømm	4,2 Ømm	5 Ømm

- Инструменты для имплантологии
  - Implantologie
  - Implantologie
- Инструменти для імплантології
  - Implantoloia
  - زراعة الأسنان

**TREPINE**

Burs with depth markings are suited for precise and simple transplantation of cylindrical bone grafts as well as for all other bone-extraction tasks.



46.9222.01 Ø Int. 2 mm Ø Ext. 3 mm  
 46.9222.02 Ø Int. 3 mm Ø Ext. 3.5 mm  
 46.9222.03 Ø Int. 4 mm Ø Ext. 5 mm  
 46.9222.04 Ø Int. 5 mm Ø Ext. 6 mm  
 46.9222.05 Ø Int. 6 mm Ø Ext. 7 mm  
 46.9222.06 Ø Int. 7 mm Ø Ext. 8 mm  
 46.9222.07 Ø Int. 8 mm Ø Ext. 9 mm  
 46.9222.08 Ø Int. 9 mm Ø Ext. 10 mm  
 46.9222.09 Ø Int. 10 mm Ø Ext. 11 mm



46.9223.01  
Tissue Punch with pin  
Set of Four Pieces



46.9224.01  
Tissue Punch  
Set of Five Pieces



46.9224.02  
Tissue Punch  
Set of Five Pieces



46.9223.01  
Trephine Drill  
Set of Eight Pieces



46.9225.01  
Trephine Drill  
Set of Eight Pieces



Ø2.0mm Ø2.5mm Ø2.8mm  
46.9224.01 Short Implant Drills  
 Ø3.2mm Ø3.65mm Ø4.2mm Ø5.2mm  
46.9224.02 Long Implant Drills



- Инструменты для имплантологии
- Implantologie
- Implantologie

- Инструменти для імплантології
- Implantologia
- زراعة الأسنان

**BONE SCRAPER STRAIGHT & CURVED**



**46.9226.01**  
Bone Scraper  
Straight

**46.9226.02**  
Bone Scraper  
Curved

**TISSUE PUNCH STRAIGHT & CURVED**



**46.9227.02**  
2.0mm

**46.9227.03**  
4.0mm

**46.9227.04**  
5.0mm

**46.9227.05**  
6.0mm

**46.9227.06**  
7.0mm

**46.9227.07**  
8.0mm

**46.9228.02**  
2.0mm

**46.9228.03**  
4.0mm

**46.9228.04**  
5.0mm

**46.9228.05**  
6.0mm

**46.9228.06**  
7.0mm

**46.9228.07**  
8.0mm

**46.9227.01**  
Tissue Punch  
Straight

**46.9228.01**  
Tissue Punch  
Curved



**46.9229.01**  
Bone Mill



**46.9230.01**  
Basins For Bone



**46.9231.01**  
BONE CRUSHER



- Инструменты для имплантологии
- Implantologie
- Implantologie
- Инструменти для імплантології
- Implantologia
- زراعة الأسنان

## KEYS FOR IMPLANT SCREW



46.9232.01



46.9232.02



46.9232.03



46.9232.04

## TORQUE WRENCH &amp; RATCHET



46.9233.01 Star Torque Wrench 6.35mm Universal



46.9239.01 Star Torque Wrench 6.35mm Universal



46.9240.03 Star Ratchet Wrench 6.35mm Universal



46.9234.01 Round Torque Wrench 4.0mm Universal



46.9239.02 Star Torque Wrench 6.35mm Universal



46.9240.04 Star Ratchet Wrench 4.0mm Universal



46.9235.01 Hex Driver With 4.0mm Driver



46.9239.03 Star Torque Wrench 6.35mm Universal



46.9240.05 Round Ratchet Wrench 4.0mm Universal



46.9236.01 Star Torque Wrench 6.35mm Universal



46.9239.04 Star Torque Wrench 6.35mm Universal



46.9240.06 Round Ratchet Wrench 3.35mm Universal



46.9237.01 Hex Torque Wrench 4.00mm Universal



46.9240.01 Star Ratchet Wrench 6.35mm Universal



46.9240.07 Star Ratchet Wrench 4.0mm Universal



46.9238.01 Star Torque Wrench 6.35mm Universal



46.9240.02 Star Ratchet Wrench 6.35mm Universal



46.9240.08 Star Ratchet Wrench 6.35mm Universal

- Инструменты для имплантологии
  - Implantologie
  - Implantologie
- Инструменти для имплантології
  - Implantologia
  - زراعة الأسنان

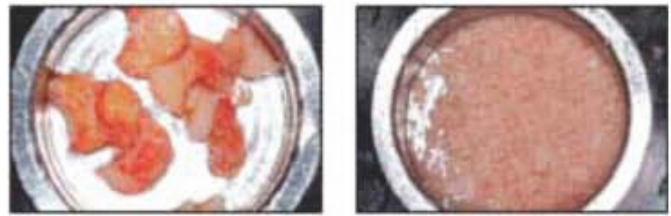

- Инструменты для имплантологии
- Implantologie
- Implantologie
- Инструменти для імплантології
- Implantologia
- زراعة الأسنان

### BONE EXPANDER SCREW & SURGICAL KITS



**46.9243.01**  
 Bone Universal Kit  
 Drill: 2mm, 2.8mm, 3.2mm, 3.65mm,  
 4.2mm, 4.5mm, 4.8mm, 5.2mm  
 Trephines Bit:  
 3.0mm, 4.0mm, 5.0mm, 6.0mm,  
 7.0mm, 8.0mm, 9.0mm, 10mm.  
 Driver:  
 2.5mm, 2.5mm Hand Pcs  
 1.25mm, 1.25mm Hand Pcs  
 Short Driver 2.5mm  
 Long Driver 2.5mm  
 1.25mm, Short Hex Driver Hand Pcs  
 1.25mm, Long Hex Driver Hand Pcs  
 Torque Wrench 4.0mm



**46.9244.01**  
 Bone Expander Kit  
 Expander: 2.6mm, 3.0mm,  
 3.4mm, 3.8mm, 4.3mm  
 Ratchet Driver  
 Parallel Pin  
 Pilot Drill  
 Drill 1.4mm  
 Drill Driver 4mm  
 Hand Driver 4mm  
 Ratchet 4.0mm



**46.9245.01**  
 Bone Universal Kit  
 Drill: 2mm, 2.8mm, 3.2mm, 3.65mm,  
 4.2mm, 4.5mm, 4.8mm, 5.2mm  
 Trephines Bit:  
 3.0mm, 4.0mm, 5.0mm, 6.0mm,  
 7.0mm, 8.0mm, 9.0mm, 10mm.

Bone Compression:  
 2mm, 3.3mm, 2.8mm, 4.2mm, 3mm, 3.5mm  
 Driver:  
 2.5mm, 2.5mm Hand Pcs  
 1.25mm, 1.25mm Hand Pcs  
 Short Driver 2.5mm  
 Long Driver 2.5mm  
 1.25mm, Short Hex Driver Hand Pcs  
 1.25mm, Long Hex Driver Hand Pcs  
 Torque Wrench 6.35mm 1 Pcs



**46.9246.01**  
 Conical Drills: 20 Pcs  
 Tissue Punches:  
 3.0mm, 3.50mm, 4.0mm, 4.5mm,  
 5.0mm, 6.0mm, 6.50mm  
 Bone Expander:  
 1.6/3.8mm, 1.9/3.0mm, 2.1/3.6mm,  
 2.6/3.8mm, 2.9/4.3mm  
 Drill Adapter: 1 Pcs  
 1.25mm, 2.50mm Hex Driver Hand Pcs

Pilot Drill: 1.6mm  
 Drill Bit: 1.4mm, 1.6mm, 1.8mm, 2.0mm, 2.2mm  
 Ratchet Driver: 4mm/6.35, 1.25/2.50  
 Rimer: 3.2/4.7mm, 3.7/4.7mm  
 Parallel Pin: 4.5mm, 2.5mm  
 Double step Drill: 2.4/2.8mm  
 Depth Gauge: 1 Pcs  
 Torque Wrench 6.35mm Universal: 1 Pcs

- Инструменты для имплантологии
  - Implantologie
  - Implantologie
- Инструменти для імплантології
  - Implantologia
  - زراعة الأسنان

**BONE INJECTORS, COLLECTORS & SUCTION TUBE**



<b>46.9247.01</b> Ø 2,5mm / 3,5mm 170mm	<b>46.9247.02</b> Ø 4,5mm / 5,5mm 170mm	<b>46.9247.03</b> Ø 3,5mm / 4,5mm 170mm	<b>46.9247.04</b> Ø 6,0mm / 7,0mm 170mm
--	--	--	--



<b>46.9248.01</b> 18cm Straight / Bend I.D 2.5mm O.D 3.5	<b>46.9248.02</b> 18cm Straight / Bend I.D 3.5mm O.D 4.5	<b>46.9248.03</b> 18cm Straight / Bend I.D 4.5mm O.D 5.5	<b>46.9248.04</b> 18cm Straight / Bend I.D 6.0mm O.D 7.0
--	--	--	--



<b>46.9249.01</b> 17.5cm With Filter	<b>46.9249.02</b> 18cm	<b>46.9250.05</b> coarse Ø 5mm	<b>46.9251.09</b> fine Ø 9mm
--	---------------------------	--------------------------------------	------------------------------------

Suction tubes to collect the extracted bone material 180mm



<b>46.9252.01</b> Suction Tubes 180mm	<b>46.9252.02</b> Suction Tubes 180mm	<b>46.9252.03</b> Suction Tubes 180mm
---	---	---



**46.9253.02**  
Ø 3 mm  
length 180mm  
**46.9253.03**  
Ø 4 mm  
length 180mm  
**46.9253.04**  
Ø 5 mm  
length 180mm  
**46.9253.01**  
Fig. 6FR  
Frazier  
15 cm - Ø 2 mm

- Оттисные ложки
- Porte-empreinte
- Abdrucklöffel
- Відбиткові ложки
- Cubetas para impresiones
- صوتی الاطباع

**PERFORATED WITH RIM LOCK**

Set of 06 Pcs

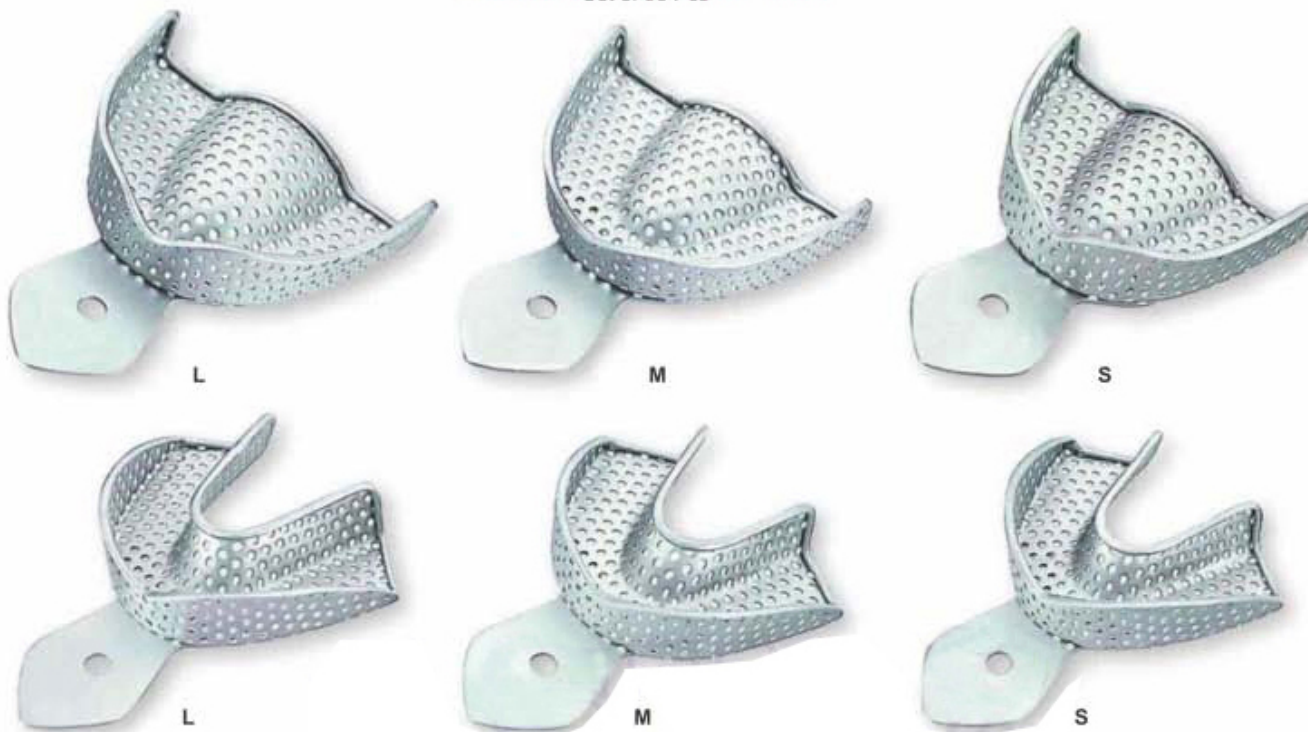

46.9254.06 **SET OF 06 PCS**  
 Upper: S, M, L  
 Lower: S, M, L

**PERFORATED WITH RIM LOCK**

Set of 8 Pcs



46.9255.08 **SET OF 08 PCS**  
 Upper: XS, S, M, L  
 Lower: XS, S, M, L

46.9256.08 **SET OF 08 PCS**  
 Upper: S, M, L, XL  
 Lower: S, M, L, XL

46.9257.10 **SET OF 10 PCS**  
 Upper: XS, S, M, L, XL  
 Lower: XS, S, M, L, XL



- Оттисные ложки
- Porte-empainte
- Abdrucklöffel
- Відбиткові ложки
- Cubetas para impresiones
- صواني الانطباع

**SOLID WITH RIM LOCK**  
Set of 6 Pcs

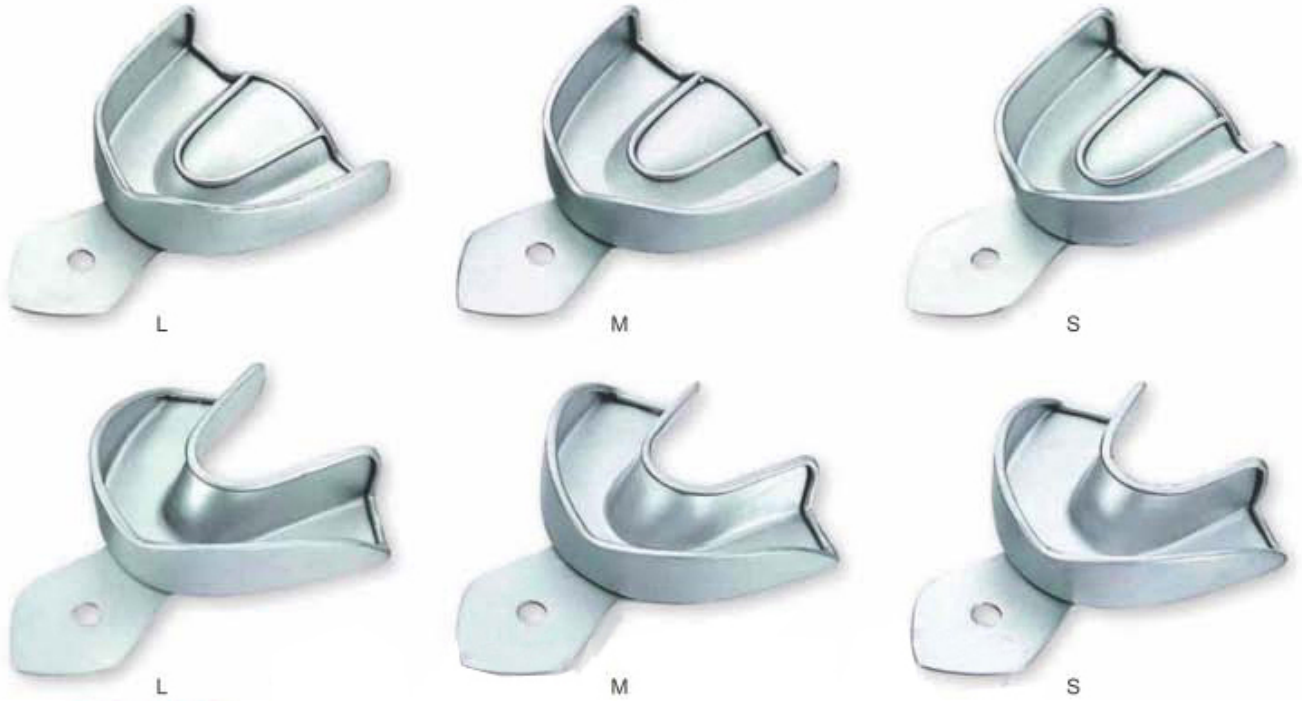

**46.9258.06 SET OF 06 PCS**  
Upper: S, M, L  
Lower: S, M, L

**SOLID WITH RIM LOCK**  
Set of 8 Pcs



**46.9259.08 SET OF 08 PCS**  
Upper: XS, S, M, L  
Lower: XS, S, M, L

**46.9260.08 SET OF 08 PCS**  
Upper: S, M, L, XL  
Lower: S, M, L, XL

**46.9261.10 SET OF 10 PCS**  
Upper: XS, S, M, L, XL  
Lower: XS, S, M, L, XL

- Оттисные ложки
- Porte-empreinte
- Abdrucklöffel
- Відбиткові ложки
- Cubetas para impresiones
- صوتاتي الاطباع

### PERFORATED FULL DENTURE

Set of 8 Pcs

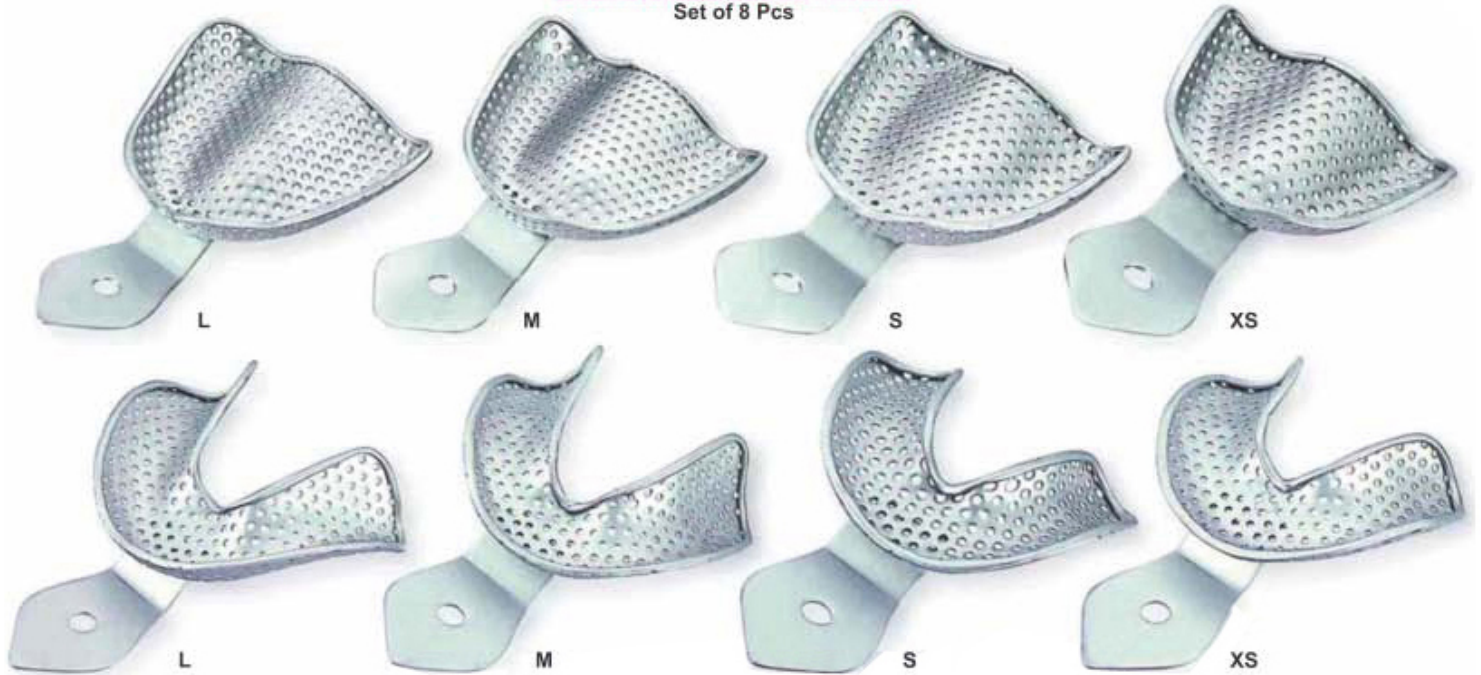

46.9262.08 **SET OF 08 PCS**  
Upper: S, M, L, XL  
Lower: S, M, L, XL

46.9263.08 **SET OF 08 PCS**  
Upper: S, M, L  
Lower: S, M, L

### 41.9516 SOLID FULL DENTURE

Set of 8 Pcs



46.9264.08 **SET OF 08 PCS**  
Upper: S, M, L, XL  
Lower: S, M, L, XL

46.9265.06 **SET OF 06 PCS**  
Upper: S, M, L  
Lower: S, M, L



- Оттисные ложки
- Porte-empreinte
- Abdrucklöffel
- Відбиткові ложки
- Cubetas para impresiones
- صواني الاطباع

**Perforated Without Rim Lock**

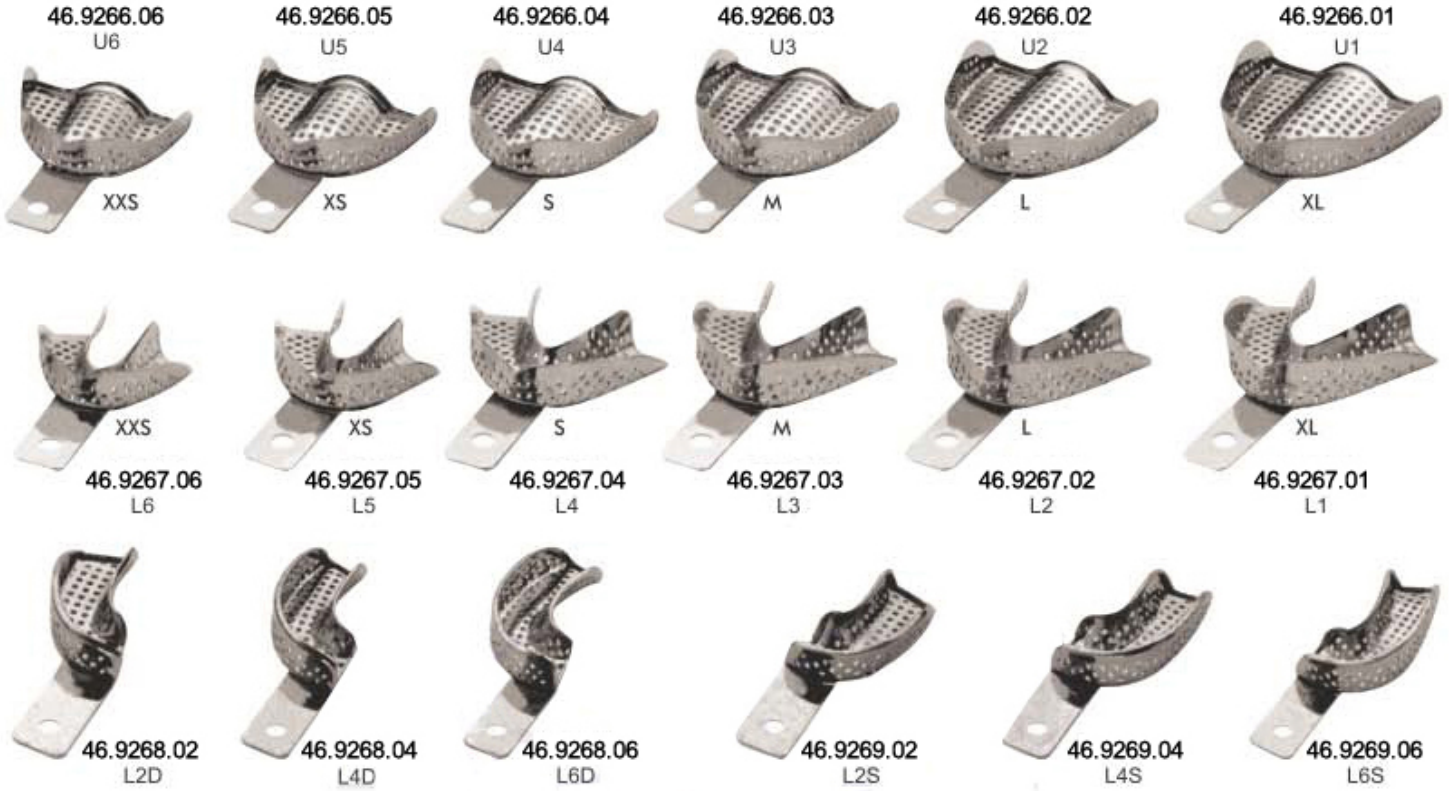

**Solid With Rim Lock**

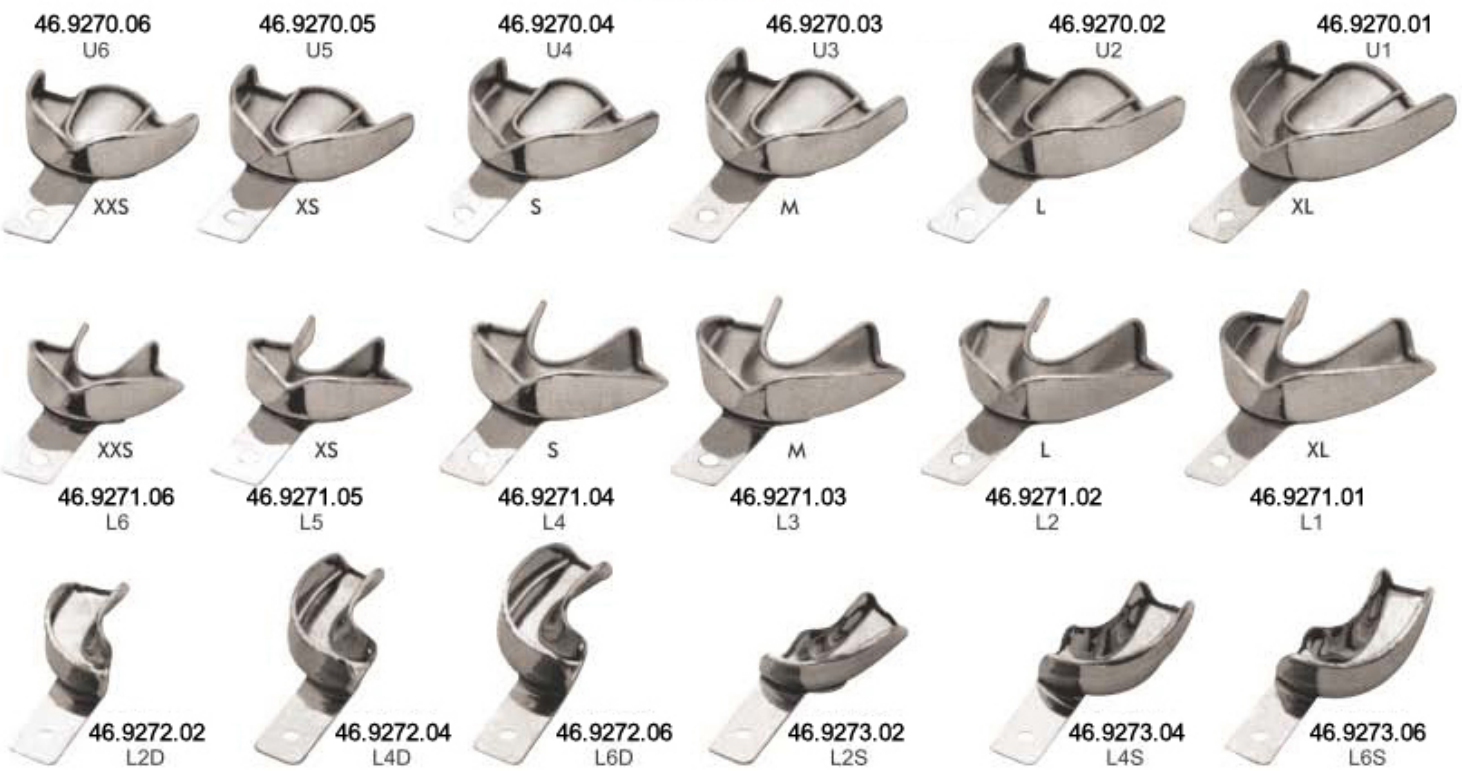



**46.9275.01**  
Instruments Cassettes  
5 Pieces, 7 Pieces, 10 Pieces & 20 Pieces



**46.9275.02**  
Instruments Cassettes  
5 Pieces, 7 Pieces, 10 Pieces & 20 Pieces

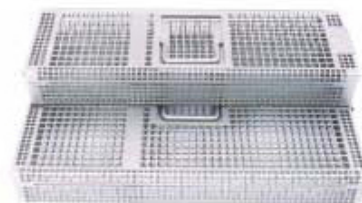

**46.9275.03**  
Instruments Cassette  
7 Pieces & 10 Pieces



**46.9276.01**  
Gracey Curette Set Cassettes



**46.9277.01**  
182 x 150 x 20 mm  
10 Instruments



**46.9277.02**  
180 x 85 x 15 mm  
5 Instruments



**46.9277.03**  
288 x 182 x 35 mm  
20 Instruments



**46.9277.04**  
288 x 182 x 35 mm  
20 Instruments



**46.9277.05**  
182 x 145 x 35 mm  
10 Instruments



**46.9277.06**  
182 x 72 x 35 mm  
5 Instruments



**46.9277.07**  
182 x 145 x 35 mm  
9 Instruments

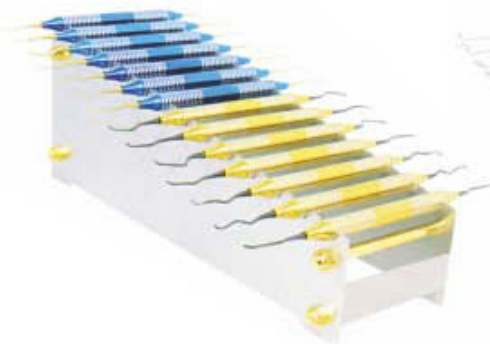

**46.9278.01**  
Gracey Curette Set Stand

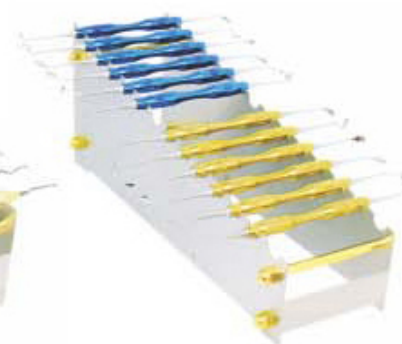

**46.9278.02**  
Sinus Lift Set Stand

**EN** Hollowware

**DE** Hollowware

**ES** Hollowware

**Page 570 to 575**



**HOLLOWWARE**



**Needle Case Round with Cover**  
30.6801.01 65x15mm



**Needle Case Round**  
30.6802.01 80x20mm



**Needle Case Rectangle**  
30.6803.01 70x70x10mm

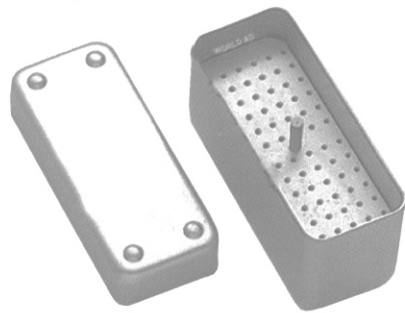

**Endodontic Box**  
30.6804.01  
100x40x50mm

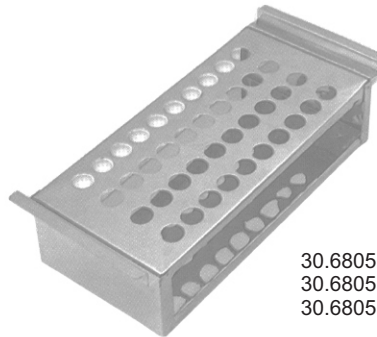

**Tube Rack**

30.6805.01 6.35x15.25x5cm for 12 tubes  
30.6805.02 6.35x17.75x7.5cm for 27 tubes  
30.6805.03 7.50x17.75x6.35cm for 36 tubes

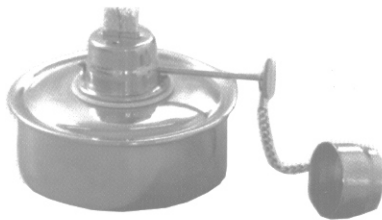

**Sprit Lamp**  
30.6806.01  
Standard Size



**Sprit Lamp**  
30.6807.01  
Standard Size



**Sputum Cup**

30.6808.01 75x80mm  
30.6808.02 100x50mm  
30.6808.03 100x80mm



**Dressing Jar**

30.6809.01	80x60mm	30.6810.01
30.6809.02	80x80mm	30.6810.02
30.6809.03	100x100mm	30.6810.03
30.6809.04	120x120mm	30.6810.04
30.6809.05	150x150mm	30.6810.05
30.6809.06	180x180mm	30.6810.06
30.6809.07	200x200mm	30.6810.07



**Dressing Jar**



**Fennle**

30.6812.01 100mm Ø  
30.6812.02 120mm Ø  
30.6812.03 150mm Ø  
30.6812.04 200mm Ø



**Cotton Holder**  
30.6811.01



**Cotton Holder**  
30.6811A.01



**HOLLOWWARE**

**Forceps Jar**

30.6813.01	30x90mm
30.6813.02	50x125mm
30.6813.03	50x170mm
30.6813.04	50x200mm
30.6813.05	40x230mm
30.6813.06	70x110mm
30.6813.07	80x150mm
30.6813.08	100x200mm
30.6813.09	150x30mm

**Medicine Cup**

30.6816.01	50ml
30.6816.02	60ml
30.6816.03	70ml

**Kick Bucket with Trolley**

30.6819.01	390x280x180mm
------------	---------------

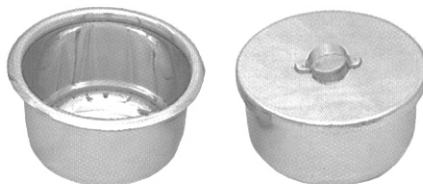
**Gallipot**

30.6814.01	01 oz	30.6814.09	09 oz
30.6814.02	02 oz	30.6814.10	10 oz
30.6814.03	03 oz	30.6814.11	11 oz
30.6814.04	04 oz	30.6814.12	12 oz
30.6814.05	05 oz	30.6814.13	13 oz
30.6814.06	06 oz	30.6814.14	14 oz
30.6814.07	07 oz	30.6814.15	15 oz
30.6814.08	08 oz	30.6814.16	16 oz

**Sponge Bowl**

30.6815.01	12 cm
30.6815.02	15 cm
30.6815.03	20 cm

**Lotion Bowl without spout**

30.6817.01	40x19mm	30.6817.08	150x65mm
30.6817.02	50x25mm	30.6817.09	180x85mm
30.6817.03	60x30mm	30.6817.10	200x100mm
30.6817.04	80x40mm	30.6817.11	250x120mm
30.6817.05	100x50mm	30.6817.12	300mm
30.6817.06	120x60mm	30.6817.13	350mm
30.6817.07	140x60mm	30.6817.14	400mm

**Wash Basin**

30.6818.01	300x80mm
30.6818.02	320x85mm
30.6818.03	330x90mm
30.6818.04	350x110mm
30.6818.05	400x115mm

**Kidney Tray**

30.6821.01	12cm
30.6821.02	15cm
30.6821.03	18cm
30.6821.04	20cm
30.6821.05	25cm
30.6821.06	28cm
30.6821.07	30cm



**Kidney Tray Shallow**

30.6820.01	17cm
30.6820.02	22cm
30.6820.03	24cm

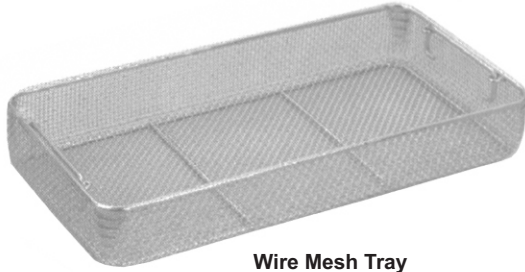

**Kidney Tray (with cover)**

30.6822.01	15cm
30.6822.02	20cm
30.6822.03	25cm
30.6822.04	30cm

**HOLLOWWARE**

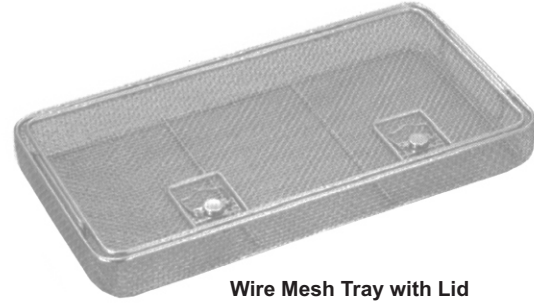

**Wire Mesh Tray**  
30.6823.01 240x250x5mm  
30.6823.02 480x250x5mm  
30.6823.03 550x250x5mm  
30.6823.04 240x250x7mm  
30.6823.05 480x250x7mm  
30.6823.06 240x250x10mm  
30.6823.07 480x250x10mm



**Wire Mesh Tray with Lid**  
30.6824.01 240x250x5mm  
30.6824.02 480x250x5mm  
30.6824.03 550x250x5mm  
30.6824.04 240x250x7mm  
30.6824.05 480x250x7mm  
30.6824.06 240x250x10mm  
30.6824.07 480x250x10mm



**Perforated Tray**  
30.6825.01 200x100x40mm  
30.6825.02 250x120x50mm  
30.6825.03 300x150x50mm  
30.6825.04 350x170x50mm  
30.6825.05 400x200x50mm



**Instruments Tray without Lid**  
30.6826.01 100x150x25mm  
30.6826.02 150x200x40mm  
30.6826.03 200x250x45mm  
30.6826.04 250x300x50mm  
30.6826.05 300x350x50mm  
30.6826.06 150x300x50mm  
30.6826.07 200x300x50mm  
30.6826.08 230x150x50mm



**Instruments Tray with Lid**  
30.6827.01 100x150x25mm  
30.6827.02 150x200x40mm  
30.6827.03 200x250x45mm  
30.6827.04 250x300x50mm  
30.6827.05 300x350x50mm  
30.6827.06 150x300x50mm  
30.6827.07 200x300x50mm  
30.6827.08 230x150x50mm



**Burr Tray**  
30.6828.01  
190x100x20mm

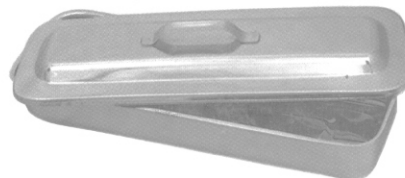

**Cathetes Tray with Lid**  
30.6829.01 300x80x40mm  
30.6829.02 350x90x45mm  
30.6829.03 400x100x50mm

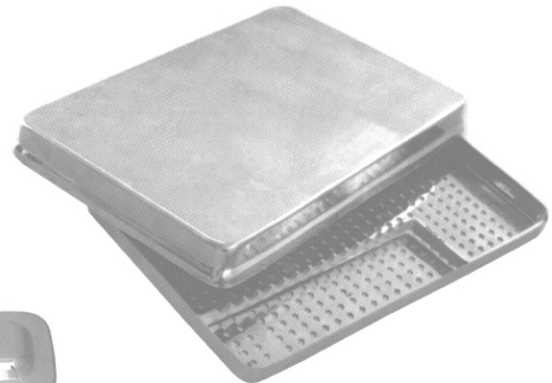

**Scaler Tray with cover**  
30.6830.01  
200x100x16mm

**HOLLOWWARE**

**Instruments Box  
with Hooks**

30.6831.01 170x70x30mm  
 30.6831.02 180x80x40mm  
 30.6831.03 200x100x40mm  
 30.6831.04 230x120x50mm  
 30.6831.05 250x125x50mm  
 30.6831.06 300x150x50mm  
 30.6831.07 350x170x50mm  
 30.6831.08 400x200x90mm  
 30.6831.09 500x200x120mm

**Instruments Box**

30.6832.01 170x70x30mm  
 30.6832.02 180x80x40mm  
 30.6832.03 200x100x40mm  
 30.6832.04 230x120x50mm  
 30.6832.05 250x125x50mm  
 30.6832.06 300x150x50mm  
 30.6832.07 350x170x50mm  
 30.6832.08 400x200x90mm  
 30.6832.09 500x200x120mm

**Instruments Box  
Perforated**

30.6833.01 200x100x40mm  
 30.6833.02 250x150x40mm  
 30.6833.03 300x150x40mm

**Electric Sterilizer**

30.6834.01 200x100x120mm  
 30.6834.02 250x120x140mm  
 30.6834.03 300x150x150mm  
 30.6834.04 350x170x170mm  
 30.6834.05 400x200x180mm  
 30.6834.06 450x230x190mm

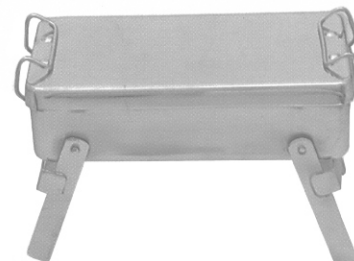
**Non Electric Sterilizer**

30.6835.01 200x100x65mm  
 30.6835.02 250x125x65mm  
 30.6835.03 300x150x100mm  
 30.6835.04 350x170x65mm  
 30.6835.05 400x200x100mm

**Electric Sterilizer**  
 30.6836.01  
 280x125x65mm

30.6837.01 125x80mm  
 30.6837.02 125x120mm  
 30.6837.03 150x100mm  
 30.6837.04 150x150mm  
 30.6837.05 180x180mm  
 30.6837.06 190x140mm  
 30.6837.07 190x190mm  
 30.6837.08 200x200mm  
 30.6837.09 240x120mm  
 30.6837.10 240x240mm  
 30.6837.11 290x140mm  
 30.6837.12 290x240mm  
 30.6837.13 290x290mm  
 30.6837.14 340x160mm  
 30.6837.15 340x340mm  
 30.6837.16 390x150mm  
 30.6837.17 390x200mm  
 30.6837.18 390x290mm

**Sterilizer Drum**

**HOLLOWWARE**



**Bedpan Hand Made**  
30.6838.01  
Standard



**Bedpan Hand Made**  
30.6839.01 Adult  
30.6839.02 Child



**Bedpan Hand Made**  
30.6840.01  
Standard



**Bedpan Simple  
pressed body with handle**  
30.6842.01 Adult  
30.6842.02 Child



**Bedpan Sleeper Type**  
30.6843.01 Adult  
30.6843.02 Child



**Bedpan Chamber Port**  
30.6844.01  
Standard

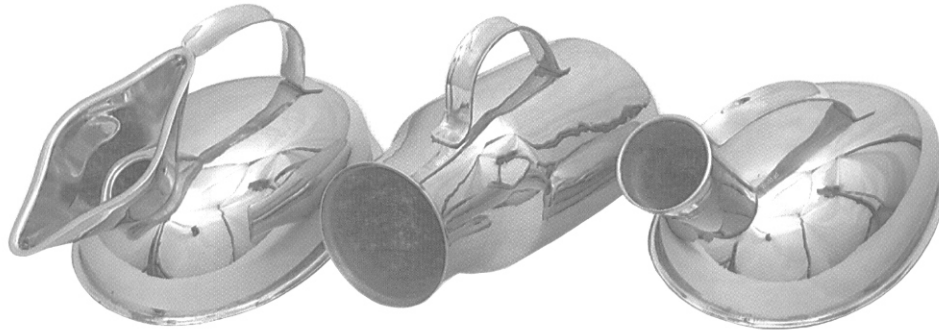

**HOLLOWWARE**

**Urinal Female**  
 30.6845.01  
 Standard

**Urinal Male Vertical**  
 30.6846.01  
 Standard

**Urinal Male**  
 30.6847.01  
 Standard



**Bedpan perfection  
 type seamless**  
 30.6848.01  
 350x300mm



**Bedpan perfection type**  
 30.6849.01 370x290mm  
 30.6849.02 320x240mm



**Dustbin**  
 30.6851.01 210mm  
 30.6851.02 240mm  
 30.6851.03 270mm  
 30.6851.04 300mm



**Pail/Bucket with Lid**  
 30.6850.01 06 Ltr  
 30.6850.02 10 Ltr  
 30.6850.03 15 Ltr



**Measuring Jug**  
 30.6852.01 0.5 Ltr  
 30.6852.02 1.0 Ltr  
 30.6852.03 1.5 Ltr  
 30.6852.04 2.0 Ltr



**Douch Can/Irrigator**  
 30.6853.01 1.0 Ltr  
 30.6853.02 1.5 Ltr  
 30.6853.03 2.0 Ltr



47.9318.01  
Endo Finger Ruler  
Span Measure Scale



47.9318.02  
Endo Finger Ruler  
Span Measure Scale



47.9318.03  
Endo Finger Ruler  
Span Measure Scale



47.9319.01  
Amalgam Gun



47.9320.01  
Brush Stainless Steel



47.9321.03  
Suction Cannula Kit  
with 3 Needles



47.9322.01  
Suction Pipe



47.9322.02  
Suction Needle  
1mm



47.9322.03  
Suction Needle  
1.5mm



47.9322.04  
Suction Needle  
2mm



**A-1 VERITAS**  
Surgident Co



## CONTACT US

**Address:** Muslim Street # 17, Khan Mehal Road  
Talwara, Sialkot - Pakistan

**TELL:** +923 32 8410 237    

**E-mail:** a1veritas47@gmail.com / a1veritas@yahoo.com

### **Vietnam office**

**Address:** 11A Hong Ha street, Didtrict Tan Binh, HCM City, Vietnam.

**CELL:** +8493 8682 214 / +92 332 8410 237

**Facebook:** [www.facebook.com/a1veritas](http://www.facebook.com/a1veritas)

[www.a1v-surgident.com](http://www.a1v-surgident.com)